

When you need a floating floor to dramatically increase your Sound Transmission Class and Impact Noise Rating

**BULLETIN
ACS-102-4**

Why not use the

MASON JACK-UP FLOOR SLAB SYSTEM

and eliminate the cost and need for:

- Combustible, rot prone plywood forms.
- A myriad of transmission paths through closely spaced supports.
- Moisture retaining fiberglass infill that plugs sub-drains and encourages vermin.

while gaining:

- An easier, lower frequency isolation method.
- A positive air gap.
- A floor supported by Mason Low Dynamic Stiffness Rubber— the time tested, low frequency, exposure-proof and truly structural material, at lower cost.

Our Riverbank Test Data demonstrates that a four-inch thick concrete floor floating on neoprene mounts improves the STC by 25 if raised two inches and that the INR goes up by 44... Tests using our lower frequency LDS mounts would add to these tremendous improvements.

Remember, the air gap is the isolator, the jack-screw lifts the floor to achieve it, and the resilient LDS element supports the weight while working in parallel with the air.

Mason Industries originated this system in 1965.

Why not work with the company that created the idea and has thousands of successful installations?

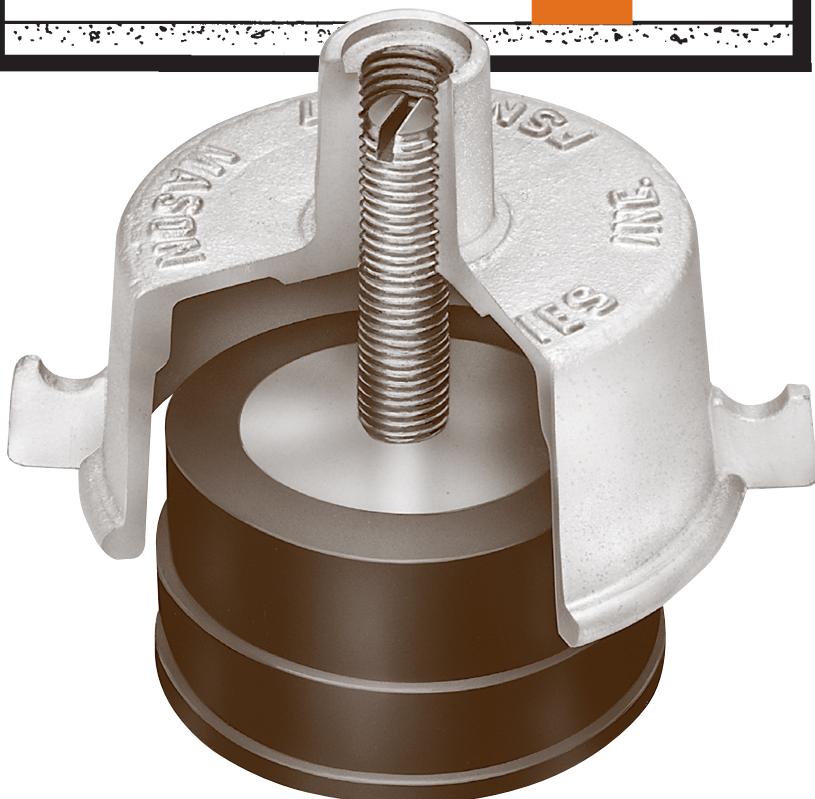
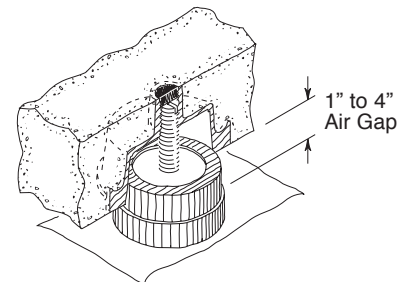

MASON INDUSTRIES, Inc.

International Manufacturers of Shock, Seismic and Vibration Control Products, Acoustical Floor Systems, Building Isolation, Rubber Expansion Joints for Piping and Stainless Steel Hoses

To the Architect:

We have been floating floors, resiliently suspending ceilings and isolating walls for close to 45 years. The need for this acoustical reinforcement has been well established in textbooks, sales literature and acoustical engineering recommendations. Therefore, we thought it would be helpful to offer a handbook of specific methods and suggested specifications rather than just print another interesting but rather general brochure.

1. There are basically two methods of reducing airborne sound transmission. The first is to increase the mass of the walls, floors or ceilings and the second is to introduce an air gap between relatively airtight constructions.
2. When dealing with a monolithic building component such as a solid concrete floor doubling the mass raises the STC by a maximum of 5. Actual test results are shown graphically on page 3. Because of this it becomes impractical to rely on mass alone as a 6" solid concrete floor has an STC of 54. Doubling to 12" raises the STC to 59. Doubling again to an unacceptable 24" raises the STC to only 64.
3. Once you decide on the maximum practical weight for the construction the next acoustical step is to split this mass into two components sandwiching an air gap. This air gap triggers a tremendous improvement in STC as shown by the Riverbank Tests of a floating floor with flanking protection. (Test Two, page 3.) Notice that the addition of a 4" concrete pour on the original 6" raised the STC from 54 to only 57. The introduction of a 2" air gap between these sections raised the STC to 79 for a dramatic improvement of 22. Increasing the air gap to 4" raised the STC to 82. Doubling the air gap raises the STC a theoretical 5, but the actual result is more like 3 because of resonances.
4. The introduction of lightweight fiberglass in the air space between massive structural elements such as concrete floors or walls is expensive and unimportant. The experimental inclusion in a 2" void increased the STC by 3 beyond the original 79. (Test Two, page 3.) This is meaningless at these levels as the 79 is all but unattainable in a commercial structure because of flanking. Fiberglass is an important addition over suspended ceilings, however, where the mass is light and the contribution noticeable.
5. The air gap is the isolator. The purpose of the vibration mounting is to provide structural support without voiding the air gap. Since each mount is a potential transmission path, it is logical that the fewer mounts or support points, the better the chance of protecting and not bypassing the air gap.
6. Specifications should be written by the professional for the protection of the client and not the protection of the vendor. Specifications should emphasize performance characteristics, physical properties and construction rather than manufacturing techniques. In describing a steel spring it would be unimportant whether the steel was produced by the Bessemer or Open Hearth method. The molder need not be told the proper curing temperature or carbon black particle size and certainly, the glass people know the specific technique for manufacturing fiberglass. It would be important in specifying steel springs to keep the operating stresses well within the elastic limit; to describe rubber mounts in terms of tensile strength, permanent set, elongation, compression set, etc. A proper dialogue regarding fiberglass would similarly cover permanent set, dynamic frequency and most importantly waterproofing tests of this sensitive material that fails when wet.
7. All vendors tend to favor their own products rather than those of their competitors. As opposed to this, an acoustical expert studies all of the available materials and recommends what in his unbiased judgment is best for the application. If there is no such person within your own organization, we continue to suggest that you retain an outside acoustical consultant to help you in this most critical field of client sensitivity.

We would appreciate your comments as to subjects not covered, our method of presenting this information or any other suggestions to make this booklet more valuable to yourselves and other people in the architectural and acoustical disciplines.

Very truly yours, MASON INDUSTRIES, INC.

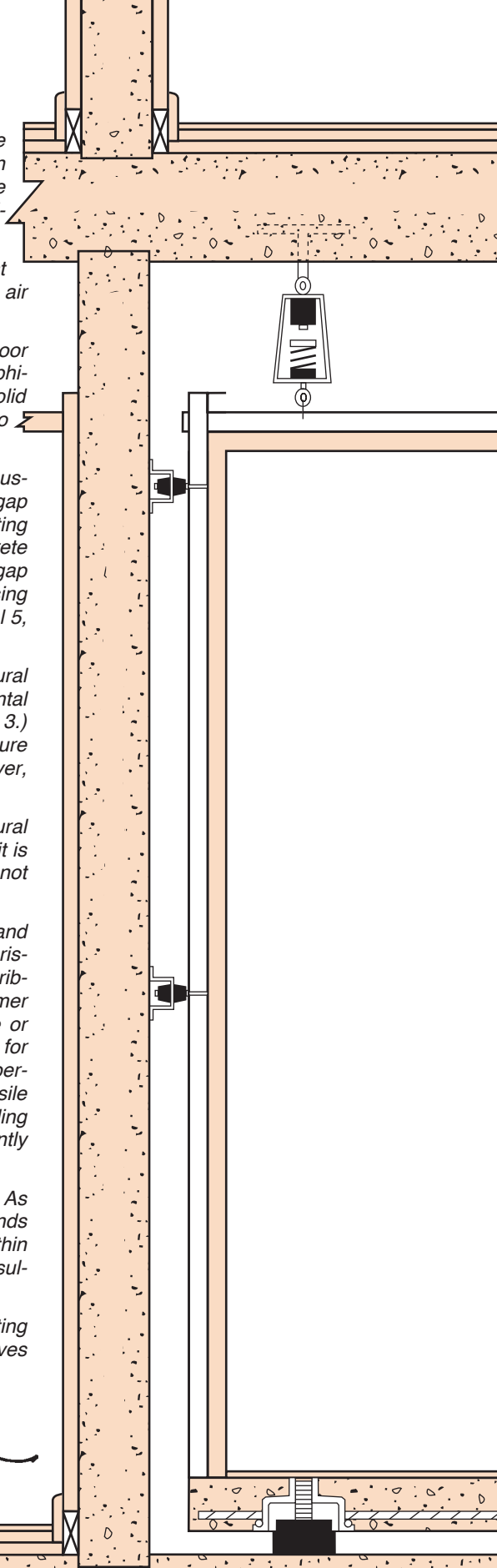

Table of Contents

Letter to the Architect	2	Spring Jack-Up Specifications	12 & 13	Isolated Ceiling Discussion	22
Technical Information & Tests	3	LDS Form-Work Specifications	14 - 18	Isolated Ceiling Specifications	23
Concrete Floating Floor Discussion	4 & 5	Isolated Wall Discussion	19	Wooden Floating Floor Discussion & Specification	24
Replacing Neoprene with LDS	6	Isolated Wall Specifications	20 & 21		
LDS Jack-up Specifications	7 - 12				



Mason 4" Thick FSN Floating Floor Tests conducted at the Chicago Riverbank Acoustical Laboratory

Effects of 0, 1", 2", 3" and 4" Air Gaps on STC & INR. Dynamic Stiffness - MASS/STC

FIRST TEST

Flanking Paths Through Walls and Ceiling

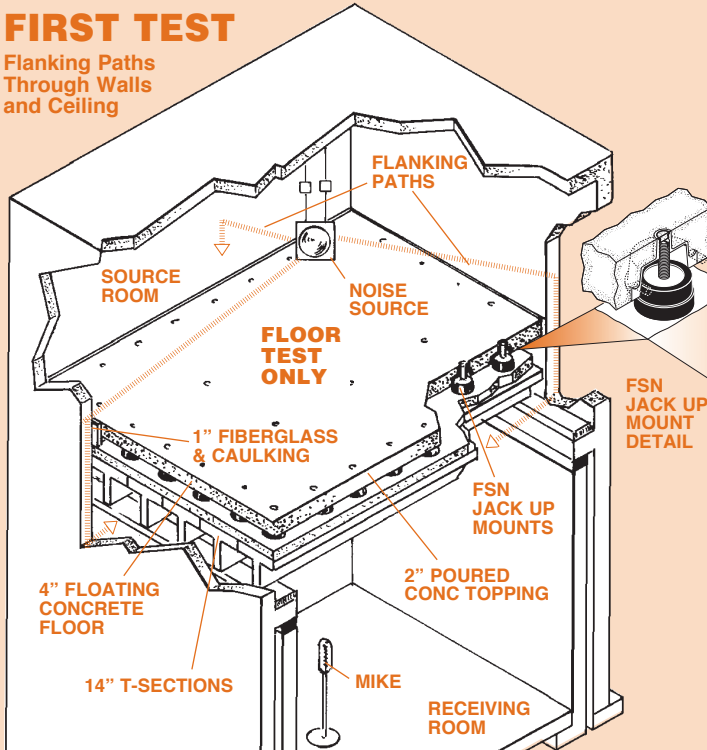

FIRST TEST MARCH 1971 OF A FLOATING FLOOR ONLY. DISAPPOINTING RESULTS BECAUSE OF FLANKING PROBLEMS DOWN THE WALLS.

SECOND TEST

With Minimized Flanking

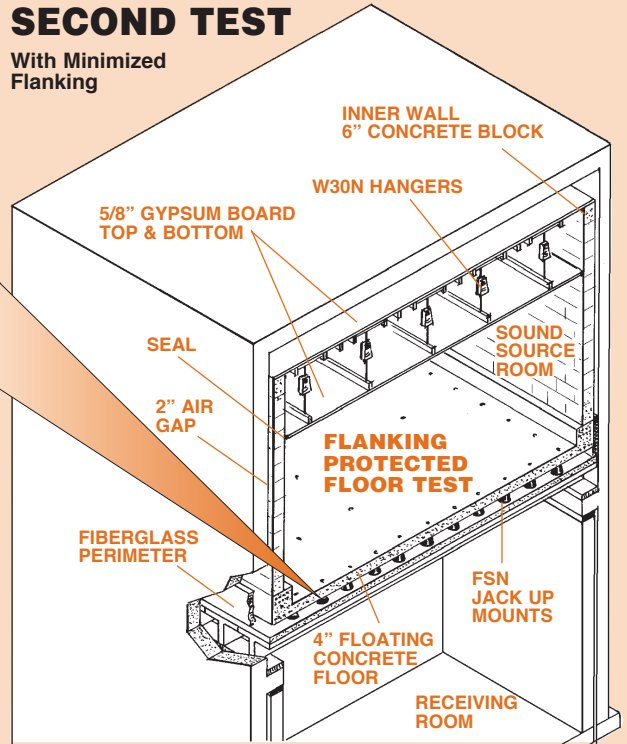

SECOND TEST JUNE 1971 OF SAME FLOATING FLOOR WITH ISOLATED WALLS AND CEILING TO PREVENT FLANKING. BASICALLY ROOM WITHIN A ROOM CONSTRUCTION.

FLANKING PROBLEM TEST DATA, ROOM WITHIN A ROOM TEST DATA

Freq. (Hertz) (cps)	TRANSMISSION LOSS (dB) COMPARISON							
	Basic T sections and 2" cover	Air gaps without fiberglass infill					2" air gap with 75% fiberglass infill	
		0"	1"	2"	3"	4"		
100	39	38 38	43 50	42 56	45 59	46 56	57	
125	39	47 47	44 57	44 60	47 62	47 63	59	
160	40	46 46	45 55	45 58	47 59	47 61	61	
200	42	49 49	46 63	45 65	46 67	46 66	68	
250	45	51 51	47 67	48 69	50 72	50 72	73	
315	49	52 52	54 73	54 75	55 77	54 78	79	
400	47	50 50	56 73	56 74	57 74	57 77	78	
500	50	55 55	58 78	59 80	60 80	60 82	83	
630	52	54 54	61 83	62 85	62 86	62 87	86	
800	51	52 52	63 85	63 86	64 87	65 86	88	
1000	52	55 55	68 88	68 88	69 88	69 87	89	
1250	55	58 58	72 93	72 93	72 92	73 91	95	
1600	58	61 61	74 97	73 96	74 95	75 93	97	
2000	60	63 63	75 97	75 101	76 99	77 97	97	
2500	62	65 65	80 101	79 104	79 101	80 101	100	
3150	65	67 67	82 104	84 105	85 107	86 103	104	
4000	68	71 71	87 105	90 106	92 105	91 104	106	
5000	70	72 74	91 102	93 101	100 99	97 99	103	
STC	54	57 57	61 76	61 79	63 80	63 82	82*	
INR		-27 -27	17 17	17 17	17 17	18 18		
IIC		-24 -24	68 68	68 68	68 68	69 69		

Riverbank TL-71-152 March 71 Riverbank TL-71-247 June 71

*While the use of infill raises the STC an additional 3 in a 2" air gap, it is overkill as field flanking will prevent achieving the higher laboratory value. The floating floor @79 STC is already the most sound resistant path.

MASON LOW DYNAMIC STIFFNESS (LDS) BRIDGE BEARING NATURAL RUBBER COMPOUNDS. DYNAMIC NATURAL FREQUENCY/DEFLECTION CHART

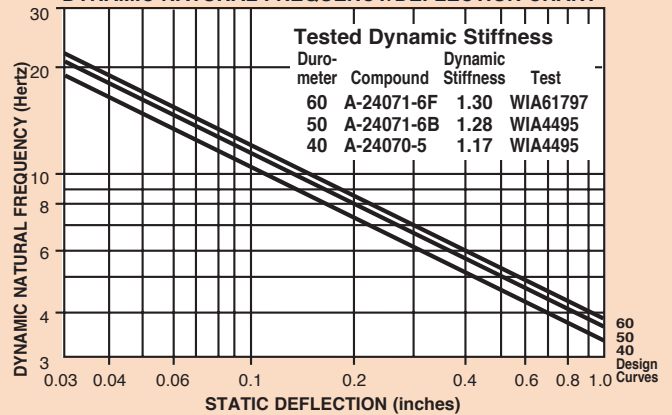

STANDARD MASS/STC LIMP MASS LAW PREDICTION AND TEST DATA

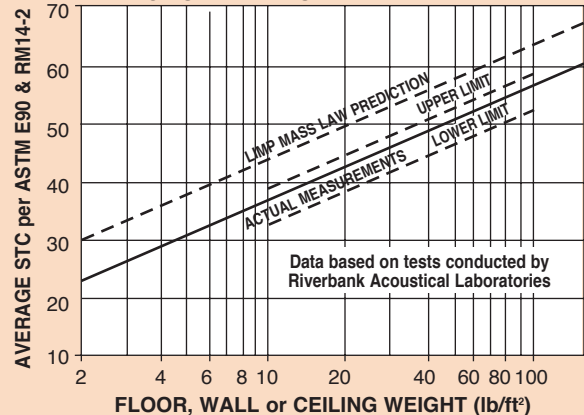



CONCRETE FLOATING FLOORS discussion

Concrete floating floors are used for many purposes. We have limited this bulletin to the following areas of Vibration, Sound and Impact Isolation.

1. VIBRATION ISOLATION

Buildings are unavoidably near busy streets, trains and subways even though they contain space that must be vibration free and have very low NC levels. Examples include television studios and theatres and in some cases sound test rooms located in the center of factories.

The frequency of the isolator supporting these floors is normally determined by the architect or an acoustical consultant depending on the input frequencies. Within our range of experience we recommend LDS mountings with a dynamic frequency not exceeding 10 Hz for input no lower than 20 Hz providing frequencies below 30 Hz are limited in amplitude. Steel spring isolators come into their own when the input is more severe or below 20 Hz. The required deflection of the springs is dependent on the input frequency, but most spring floating floor work is done with deflections between 0.5" and 0.75" to provide frequencies in the 4.5 to 3.6 Hz range. When heavy impact is a major factor, springs are always required.

We have provided LDS isolators to reduce subway vibration at grade. They were very effective as the lowest input frequency was measured at 20 Hz and the ground amplitudes were small. In another application, however, television studios were located on the third floor of an old building. Spring mountings were specified by the same acoustical consultant as the upper floor amplitudes were high and frequencies low, not only because of motor truck traffic outside the building, but the passage of heavy scenery wagons in halls between studios.

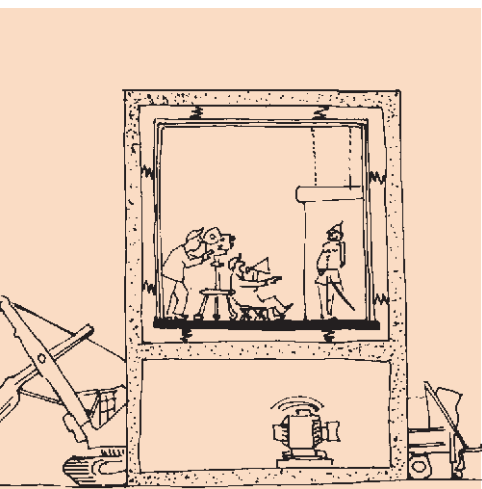

VIBRATION

2. SOUND ISOLATION

Typical of these applications are the introduction of floating floors in very noisy equipment rooms located over prime office space or floating roofs as a protection against aircraft noises.

Since we are dealing with the prevention of airborne noise transmission only, LDS mountings are always the choice. The lowest audible frequency is about 25 Hz so there is no need for mountings of greater deflection. Spring mountings manufactured with LDS materials in series with the springs would work equally well in this application, but they are needlessly expensive. Since the floating floor's frequency is too high to isolate machinery, the only function is the prevention of airborne sound transmission. Machinery supported on the floating floor must have steel or air spring isolators.

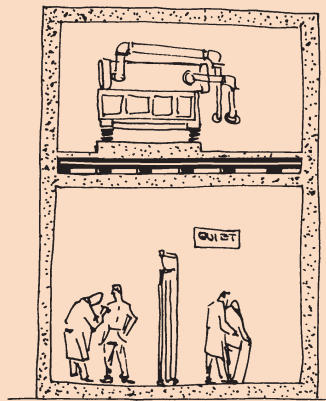

SOUND

3. IMPACT ISOLATION

Examples of straight impact isolation would normally include kitchens, weight rooms or bowling alleys. A commercial kitchen in an office building generates structurally transmitted noise. The noise level within the kitchen itself might not be very high, but the rolling of carts, the dropping of dishes, the rattling of cutlery on steel tables, the placing of pots on stoves, etc., all represent impact and mechanically transmitted sound. LDS isolators have been effective in most of these applications but springs are better.

Where gym floors are the problem and we must deal with running, jumping and bouncing balls, LDS would be effective over a very rigid substructure, but once again springs are the safer approach.



IMPACT

JACK-UP (Lift-Slab) SYSTEM

We believe that the most fool-proof and safest way to establish the air gap is the jack-up or lift-slab method. Plastic sheeting is placed on the sub-floor as a breaker layer, isolators are placed on the plastic sheeting, reinforcing steel or mesh rests on the isolator housings, and the concrete floor is poured. After the concrete has cured, the slab is lifted to elevation by turning adjustment bolts above each isolator to any specified air gap between 1" and 4".

FORM-WORK SYSTEM

The alternate, almost obsolete, method is one whereby a continuous layer of the isolation media is used as a pouring surface. More commonly, individual isolators, the thickness of the air gap are placed in position in the field and covered with plywood or factory attached to plywood before delivery. The upper surface is covered with a plastic layer and then the reinforcing is placed on top of the plywood forms and the concrete poured at finished elevation.

MACHINERY SUPPORT

In our older publications we advocated the support of heavy machinery on full sized structurally supported pedestals or individual structurally supported pedestals as shown in the illustrations on page 5. While the performance of systems installed that way was excellent, it proved to be a major coordination problem because the pedestals had to be located, poured and anchored to the sub-floor before the system could go ahead. There was very little saving in cost as we provided isolators around the edges of these pedestals so there was no saving in the number of isolators. There was the additional labor of installing perimeter board and caulking. We gradually modified our approach to using this method for only the heaviest of machinery such as chillers, but based on our continued experience we are now suggesting continuous floating floors with all the housekeeping pads and equipment on top.

JACK-UP VERSUS FORM-WORK METHOD

When the form-work method is used, the spacing of the mountings is a function of the stiffness of the forms which support the wet concrete. In using half inch plywood, which is the most common form, we have tested 12", 16" and 24" spacing. We have found 24" spacing to be highly satisfactory. Closer spacing merely means more fussing with light capacity mountings and in comparing 12" with 24" spacing the introduction of four times as many transmission points.

Our development of the lift-slab method accelerated in 1962 when we isolated some 30,000 square feet of television studios for CBS using jack-up spring mountings. The mountings were designed to the performance specifications of an acoustical consultant. This new method was an immediate success.

When using the lift-slab technique, the spacing of the isolators is determined by the thickness of the floating floor and the reinforcement. When 4" slabs are used, a spacing of 54" in both directions is well within design limitations. Thus we have 1/20 the number of transmission pads offered by a form work or panel system using 12" spacing. Thicker slabs allow for wider spacing and 60" or more is not unusual.

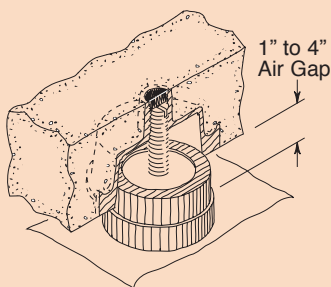

JACK-UP FLOOR
Recommended Spacing 54"



Structural tests run in 1974 indicate that 48" spacing using 6x6x10 gauge mesh 1" from the bottom is a very safe system for live loads of 150 Lbs. per square foot, or rolling loads of 350 Lbs. per lineal foot. Rolling loads must be considered when rigging machines into place. These allowable loadings were derived from destruction tests, and based on a 3 to 1 safety factor. The full certified Jones Test Report is available on request. Extremely heavy concentrated loads are accommodated by isolators directly under the loads or by using heavier local reinforcing to carry the load to mountings paralleling the equipment. Heavier reinforcement allows greater spacing.

The most advantageous way of using the jack-up system is to roll the heavy equipment into position before the floor is raised, so there is no danger of cracking the areas of lighter capacity as the machinery rolls by. The floors are raised with the machinery in place. When it is done this way, all mountings have the most uniform deflection. While this is the ideal way, the concrete people usually want to be off the job and the machinery is placed after the floor is raised. This is no problem either, as a lifted floor is no different than a floor poured at elevation.

In thinking about longevity it seems to be a contradiction to use plywood as the form in series with the isolator. If moisture is present, even exterior plywood will eventually rot. Plywood between floors is a fire hazard that violates many state codes and fireproof plywood is very expensive. Why worry about these problems when the plywood can be omitted with the jack-up system?

When deformed metallic forms are specified, many of these objections no longer exist as in one direction the support mountings can be moved out to the larger centers. Fire and rotting is similarly no longer a problem. However, very few floors are installed this way as steel forms are expensive and difficult to install, particularly in odd shaped rooms.

We have omitted the use of lightweight fiberglass infill in all of our recommendations, because the acoustical improvement is negligible as shown in paragraph 4 of the opening letter on page 2. When water is present between floors, the breakdown of the lightweight fiberglass tends to clog drains and to hold and carry moisture up to the plywood. This accelerates rotting whether the drains are introduced in the sub-floor or not.

The jack-up system is easier to install since there is no need to fit unusual contours. The mountings are placed in position along the edges and the concrete flows to or around the odd shapes. Any air gap up to 4" can be used at no increase in cost. Perhaps the most important point is that there is no possibility of short circuiting of the air gap by concrete spills between plywood panels. When these accidents happen, there is no way to tell until the floor does not perform properly. In effecting repairs you must first locate the short circuit, break or cut out that area of the floor, somehow re-establish the reinforcing by welding or tying to the stubs that are left and then repouring the patch. This can never happen with a lift-slab system as the floors are lifted after the concrete has hardened so the air gap must be clear.

When using the jack-up system, the isolator is within the cast iron housing, so the thickness of the isolator remains 2", even if the floor is only elevated 1". If you try to save height with a plywood system, the thickness of the isolator must be reduced with a loss in efficiency because the isolator frequency increases. We have installed floors that are 3" thick with a 1" lift for a total height of 4". A plywood system with the same isolator frequency would have to be 5 1/2" high minimum. The 1 1/2" height saving can be important.

While we prefer the lift-slab system, we have also included specifications using plywood forms as there is the occasional application where the forms are practical or for reasons of your own you prefer this older technique.

EXTREME TRANSIENT LOAD CONDITIONS

Floating floors are sometimes subject to extremely high transient loads that would deflect the floor beyond structural limits and result in floor failure. Typical of these are stage floors, floating streets, convention exhibit centers and major production TV studios. Temporary loadings are buses, trailer trucks or lift trucks with concentrated loads as high as 10,000 lbs. in any location. These problems are handled with stop screw isolator designs. The main adjustment bolt is enlarged to a threaded brass bushing with a centered steel bolt set to a predetermined clearance above a secondary base isolation plate and isolation pad. Let us discuss these specialized applications with you as each problem is different.

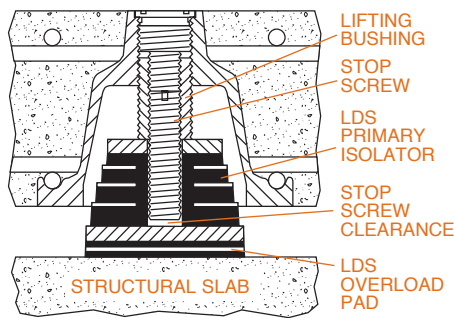

STOP SCREW FSN
Also available for FS (spring)

SEISMIC CONSIDERATIONS

In seismic zones the peripheral walls or curbs must be studied and designed to withstand horizontal floating floor displacement at the maximum acceleration in the area. Typically a 5,000 square foot floor would weigh 250,000 Lbs. and the weight of any equipment attached to the floor would have to be added to that. If the system were in a 0.5g zone, the lateral force would be 125,000 Lbs. Assuming the dimensions were 50 ft. x 100 ft., the 50 ft direction would be most critical and the curb or perimeter wall designed to resist 2500 Lbs. per linear foot.

Another potentially serious problem is the curling and failure of the concrete floor from the forces introduced by the machinery restraints that must be anchored to the floating floor. The problem becomes apparent when you visualize a tall, narrow chiller. Acceleration at the center of gravity creates an overturning moment that pulls on the floor on one side and depresses it on the other. A 4" concrete floor has little inherent resistance to this type of bending and we have addressed this problem with a double acting resilient floor snubber type SFFS as illustrated on page 8 and 14.

The snubber is anchored to the sub-floor and the housing cast into the floating floor. The up and down clearances are adjusted after the floor has been raised. The floor restraints are grouped near the points of tension and compression or on either side of the housekeeping pads. The inclusion of these snubbers keeps the floor captive and prevents damage. The generous clearances prevent short circuiting. We believe we are the first, if not the only company, to offer this engineering development.

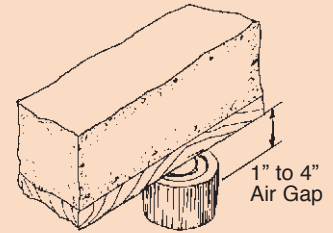

FORM-WORK FLOOR
Maximum Spacing 24"

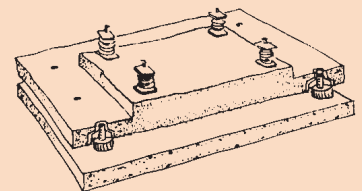

HOUSEKEEPING PAD ON FLOATING FLOOR

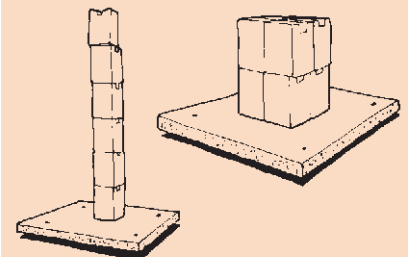

CONCENTRATED LOAD TESTS

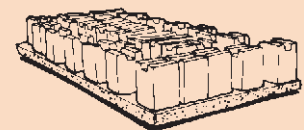

UNIFORM LOAD TEST

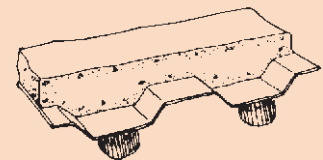

DEFORMED METALLIC FORMS



IMPROVED PERFORMANCE BY REPLACING NEOPRENE WITH LDS (Low Dynamic Stiffness) RUBBER

We started Mason Industries in 1958. Our revolutionary designs of high deflection free standing spring isolators, as opposed to housed mountings, and our literature with down to earth information made its mark. This generated phone calls from acoustical consultants asking us to get into the floating floor business. We asked why. In addition to wanting more than one source, the implication was that some competitive information was unreliable and they would rather work with us.

In those wonderful days we were doubling our volume every year and keeping up with demand and continued development of our mechanical systems, led us to answer, we simply were not ready to enter the floating floor market.

In 1965 one of our representatives ordered Bridge Bearing Neoprene Pads. While we had been molding rubber for years, we were not familiar with this specification.

DuPont manufactures Neoprene, and they were a great help. In addition to the Bridge Bearing formulations, they provided publications and back up information on Neoprene's excellent aging characteristics.

After this exposure to Neoprene, we realized we had a proper floating floor material. If Neoprene could survive in outdoor applications, exposed to sunlight, temperature extremes, snow and rain, it would certainly last for the life of the structure when located in the dark, cozy, moderate temperature environment, under a floating floor. We immediately phoned the acoustical consultants, and asked what frequency they needed

We were told they wanted an isolation frequency of 8 Hz in a 2" air gap. Since the lowest audible frequency is 25 Hz. 25/8 provided an acoustical ratio of 3/1, similar to minimum vibration isolation, and at the higher frequencies, sound loss would improve dramatically.

We learned that rubber materials are often deflected 10% of the rubber thickness, and many publications refer to 15% deformation as a good conservative compression limit. That is why our 2" thick isolators have published deflections of 0.2" and a maximum of 0.3".

Dynamic Stiffness is simply defined as the ratio between the spring rate in vibratory motion and the static spring rate.

When working with steel springs, the ratio is 1, as spring steel is a completely resilient material. Rubber materials are quite different. Dynamic stiffness increases with hardness and in broad terms, the filler ratio of the materials to the rubber content as well as the type of carbon black reinforcement, plasticizers, etc. It is also very sensitive to the polymer.

We ran our Kodaris Neoprene Dynamic Stiffness test in 1972. The corrected data showed that at 0.2" deflection, the poorest situation using 60 duro with a dynamic stiffness of 1.63 increased the frequency to 9 Hz at 0.2" and 7.3 Hz at 0.3" as compared to a steel spring where 0.2" deflection would be 7 Hz and 0.3" 5.7 Hz.

In negotiating a recent building support project, we convinced the client that Neoprene should be used in place of Natural Rubber. We were not concerned that the specification required a new dynamic stiffness test, because we believed the Kodaris test data showing our 50 durometer Neoprene compound had a dynamic stiffness of 1.50 and 60 durometer 1.63. However, the dynamic stiffness tests run today are very different, and

much more sophisticated. It is a forced frequency test for resonance at specific frequencies of 5, 10 and 15 Hz. We were dismayed to find that rather than 1.5 to 1.63, the new results ranged from an average of 1.8 for 54 durometer to 2.4 for 64. Using the same test techniques, our new LDS rubber compounds are below 1.3 in 50 durometer and 1.35 in 60. This meant the continued use of Neoprene represented too great a sacrifice in performance.

LDS stands for **Low Dynamic Stiffness**. In addition to exceeding all AASHTO Bridge Bearing structural requirements, we had worked for years to develop compounds with extremely Low Dynamic Stiffness characteristics even in 60 and 70 durometer as published. Using these compounds lowers frequency response for a given deflection to improve both vibration isolation and reduce sound transmission. Other than oil resistance, Mason LDS compounds are far superior to Neoprene in physical characteristics as well. Building Support Pads can have a lower profile than Neoprene for the same frequency. This is true of floating floor mounts too, but mounting heights are often maintained to achieve a specified air gap.

In Europe, virtually all isolation work was and is done with Natural Rubber. In this country, specifications for bridge bearing rubber supports allow the use of Neoprene or Natural Rubber. The very great majority of bearings, if not all, are Natural Rubber. However, there is no requirement for a low dynamic stiffness, so the compounds are made less expensive by using more fillers and are considerably less efficient than our designs acoustically. In supporting bridges, this is unimportant as bearings are used in shear to accommodate expansion and contraction and not for vibration isolation.

There is a mechanical aspect too. Most engineers and architects are in the habit of pouring concrete on forms with the bearings directly underneath or erecting steel directly on the bearings. In this first stage, the loadings are very low so the bearings hardly deflect. As the building progresses, the bearings deflect in response to the added weight, which is not always uniform. The more deflection required to achieve a frequency, the greater the complication of uneven deflections that may distort the structure or induce cracks. LDS compounds minimize that problem, because deflections are minimal for the same frequency.

The use of Natural Rubber has been guided by the Malaysian Rubber Institute, and just as DuPont has been promoting Neoprene and other excellent special purpose polymers, the Natural Rubber industry has been working with the chemical people to perfect the antiozonants and antioxidants. Other additives reduce sunlight damage. The new Natural Rubber materials have become completely reliable in long term aging tests, so there is no longer any reason to continue with the Neoprene. We have always improved our offerings, and hopefully, our learning curve will continue.

Based on these conclusions, all acoustical isolation materials, including the mounts used in Jack-up systems, the EAFM series, or bearings to support and isolate structures will be made of LDS materials. (Low Dynamic Stiffness.) Hanger elements and hanger cups are included as well.

While the danger of oil contamination is minimal, all floor mounted pads under spring isolators, spring holders, etc., will continue as commercial grade Neoprene.

Norm Mason



MECHANICAL EQUIPMENT ROOM LDS JACK-UP SYSTEM beginning of specifications

FLOATING FLOOR CONSTRUCTION SEQUENCE

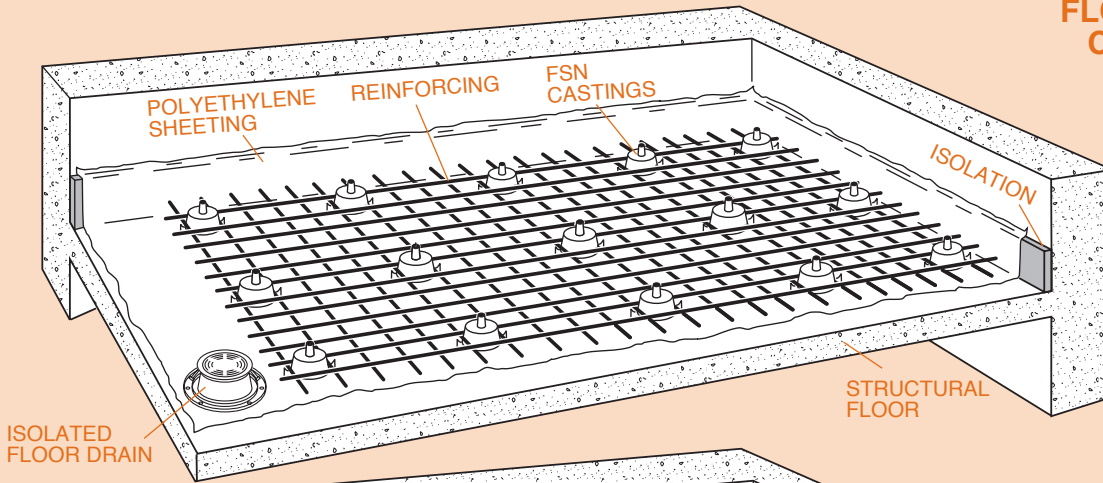

PLACEMENT OF ISOLATION MATERIALS

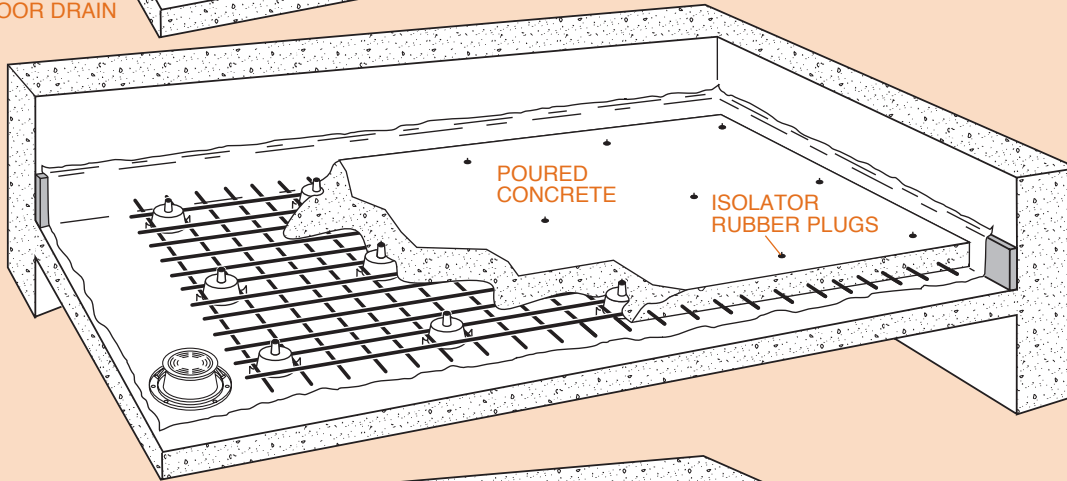

POURING OF CONCRETE

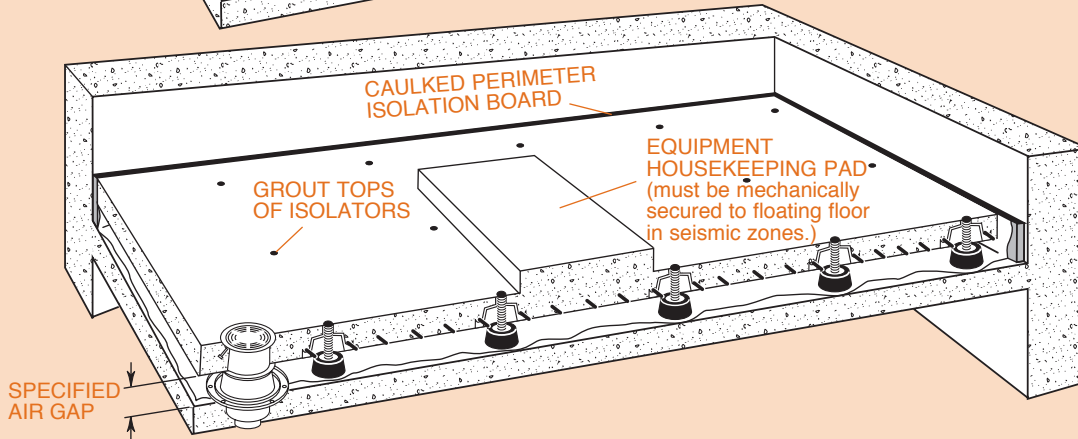

JACKED UP FLOATING FLOOR

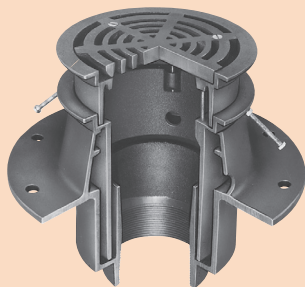

Type CFDA4 x 4
FLOOR DRAIN

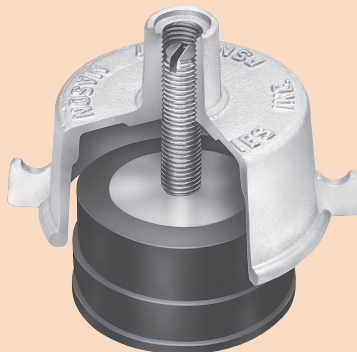

Type FSN
LDS JACK-UP MOUNT

The following floor specifications are all written in the format of the "United States Construction Specifications Institute". All specifications are available upon request on CD Rom.

LDS JACK-UP SYSTEM FOR MECHANICAL EQUIPMENT ROOMS WITH MACHINERY SUPPORTED BY THE FLOATING FLOOR.

PART 1 - GENERAL

1.01 Description

A Scope of Work

1. Isolate floating floors from building structure by means of jack-up LDS isolators and perimeter isolation in each of the mechanical equipment rooms as shown on the drawings.

If sound barrier walls are used, add the following:

2. Build sound barrier walls on the floating floors.

B. Substitution of Materials

1. Substitute materials shall meet or exceed the "quality" of the prod-



MECHANICAL EQUIPMENT ROOM LDS JACK-UP SYSTEM specification continued

ucts which are listed in these Specifications. Submit samples and test reports by an independent laboratory for consideration on this project.

1.02 Design

A. Intent

1. The floating floor system shall consist of a 4"(100mm) thick concrete slab isolated from and supported 2"(50mm) above the waterproofed structural slab by resilient LDS isolators within cast iron housings designed to jack up the floor after pouring on the sub-floor.

If sound barrier walls are used, add the following:

Sound barrier walls consisting of 6"(150mm) filled concrete block (Barrier wall construction can be changed when writing specification) shall rest on the floating floor with a 3 1/2" air gap to the structural walls. (3 1/2"(90mm) may be reduced to 2"(50mm) if no sway braces are needed.)

2. The floating floor slab shall be isolated from adjoining walls, columns and curbs by means of perimeter isolation.
3. Any floor drains, piping, conduit and duct penetrations must not short circuit the isolation system.
4. Any equipment within these rooms shall be mounted on housekeeping pads or directly on the floating floor as shown on the drawings.
5. In seismic zones the floating floor shall be restrained horizontally by curbs or walls designed to withstand the horizontal seismic forces. Solid bridge bearing LDS pads shall be interspersed between perimeter isolation to withstand the seismic forces with a maximum deflection of 0.2"(5mm). When perimeter cannot be used for seismic constraint, intersperse horizontal restraints within floor system.
6. In seismic zones 2, 3 and 4 or equivalent Av, the floor shall be protected by embedded double acting resilient floor snubbers set in opposition to the overturning moments at the equipment snubbers in all locations where the center of gravity of major equipment is high.

B. Performance Requirements

1. The floating floor system shall have a minimum rating of STC-79 and INR+17 as verified by an independent laboratory in prior tests.

C. Floor System Construction Procedure

1. The setting of all isolation materials and raising of the floor shall be performed by or under the supervision of the isolation manufacturer.
2. Set and waterproof any drains and lower pipe seals in keeping with waterproofing specifications.
3. Cement perimeter isolation around all walls, columns, curbs, etc.
- 3a. In seismic zones intersperse the perimeter isolation with bridge bearing quality LDS pads the thickness of the perimeter isolation or bolt to the sub-floor.
4. Cover entire floor area with 6 mil (0.15mm) plastic sheeting and carry sheeting up perimeter isolation.
5. Place bell-shaped castings on a maximum of 54"(1370mm) centers in the general areas in strict accordance with the approved drawings prepared by the isolation manufacturer. Spacing can be increased to straddle machinery locations. Additional reinforcement must be detailed on isolation manufacturer's drawings when required.

If sound barrier walls are used, add the following:

Perimeter isolators shall be selected to support the wall weight in addition to the perimeter of the floating floor.

- 5a. In seismic zones attach double acting resilient seismic snubbers to the structural slab on either side of high center of gravity equipment to withstand the overturning moment generated by the machinery snubbers and prevent failure of the floating floor.
6. Place reinforcing as shown on the drawings and pour floor monolithically.
7. Raise floor 2"(50mm) by means of the jack-screws. (If construction sequence dictates raising the floor before placing machinery, heavy planking must be used to protect floor while machinery is being rolled into position).
8. Caulk perimeter isolation in all locations and grout jack-screw holes.

If sound barrier walls are used, add the following:

9. Construct block walls on the floating floor being careful that mortar does not drop behind the walls. Place 2"(50mm) fiberglass bats against the structural wall as a precaution. Provide sway braces and isolated angle iron wall braces at the top of the walls. Caulk angle iron braces.

10. In seismic zones adjust the double acting snubbers after machinery is in place to provide a maximum up and down clearance of 0.125"(3mm).

D. Submittals

1. Detailed product drawings and Load/Deflection curves of all isolators, double acting floor snubbers and/or other snubbing restraints when required.
2. AASHTO Test Reports on all properties in table 2.01 A from an accredited independent laboratory for all rubber durometers used.
3. Dynamic stiffness test from an accredited independent laboratory at 5, 10 and 15 Hz, showing dynamic stiffness does not exceed 1.4.
- 3a. Isolation frequency not to exceed 9 Hz at stated deflection.
4. Acoustical test data from an independent laboratory showing a minimum STC of 79 and a minimum INR of 17 using a 4"(100mm) concrete floating floor, a 6"(152mm) structural floor and a 2"(50mm) air gap.
5. A drawing or drawings showing:
 - a. Dead, live and concentrated loads.
 - b. Isolator sizes, deflections, frequencies and locations and in seismic zones, locations of seismic snubbers.
If sound barrier walls are used, add the following to b:
Wall sway brace and isolated angle iron brace sizes, locations and frequencies.
 - c. Any drain and penetration locations.
 - d. Size, type, elevation and spacing of concrete reinforcement.
 - e. Caulking details.
 - f. Floor or floor and wall construction procedure.

1.03 Quality Assurance

- A. Floating floor system components shall be designed and fabricated by a manufacturer with at least ten years experience in one hundred similar installations.
- B. The floating floor isolation materials shall be installed and the floor raised by or under the supervision of the isolator manufacturer.

1.04 Site Conditions

- A. If site conditions are unsatisfactory or raise questions about the installation of the floating floor, the work will not proceed until the condition has been corrected in a manner acceptable to the isolation manufacturer. The sub-floor must have the same pitch as the top of the floating floor or special provisions made for isolator housings of different height.

1.05 Sequencing and Scheduling

Coordinate work with other trades and coordinate scheduling with the construction supervisor to minimize delays.

PART 2 - PRODUCTS

2.01 Isolators

- A. Bell shaped castings with integral lugs to locate reinforcing, shrouding 2"(50mm) thick LDS isolators molded to the following and all other AASHTO bridge bearing specifications. All housings shall have 3/4"(20mm) minimum diameter jackscrews. Deflections shall not exceed 0.3"(7.5mm) nor the frequency 9 Hz. Isolators shall be Mason Industries type FSN.

Table 1. AASHTO BRIDGE BEARING SPECIFICATIONS FOR POLYISOPRENE

ORIGINAL PHYSICAL PROPERTIES			TESTED FOR AGING			COMPRES-	LONG
			OVEN AGING(70hrs/158°F)			SION SET	TERM
Tests: ASTM D-2240 & D-412			ASTM D-573			ASTM	CREEP
Duro-	Tensile	Elongat.	Hard-	Tensile	Elongat.	25 pphm in air	ISO8013
meter	Strength	(min)	ness	Strength	(max)	by Vol. 20%	
Shore A	(min)	(min)	(max)	(max)	(max)	Strain 100°F	168 hrs
40±5	2000 psi	500%	+10%	-25%	-25%	No Cracks	5%(max)
50±5	2250 psi	450%	+10%	-25%	-25%	No Cracks	5%(max)
60±5	2250 psi	400%	+10%	-25%	-25%	No Cracks	5%(max)
70±5	2250 psi	300%	+10%	-25%	-25%	No Cracks	5%(max)

NOTE: 40 Durometer is not included in AASHTO Specifications. Numbers are Mason standard.

- B. In seismic zones double acting resilient cast in floating floor snubbers shall consist of a ductile iron housing locked into the floating floor. The housing shall have a removable cover plate to provide access to the adjustment of clearances in both the up and down directions of the resilient stops. Resilient stops shall be attached to a restraining bolt attached to the structural floor with an approved anchor. Double acting snubbers shall be Mason Industries Type SFFS.



MECHANICAL EQUIPMENT ROOM LDS JACK-UP SYSTEM specification concluded

If sound barrier walls are used, add the following:

- C. Wall Sway Braces: Double acting LDS sway braces with a fail safe feature in three planes. Braces shall be furnished with a bracket for bolting to the structural wall and a hooked end for insertion in the masonry joint. Braces shall have a frequency not in excess of 10Hz based on the weight of the wall area per brace and a vertical stiffness not in excess of 50% of the horizontal. Sway Braces shall be Mason Industries Type DNSB.
- D. Angle Brackets: 1 1/2"(40mm) x 2"(50mm) angle iron sections with provision for bolting to the structure and a minimum thickness of 3/8"(9mm) sponge cemented to the vertical leg. Angle Brackets shall be Mason Industries AB-716.

2.02 Bond Breaker Material

- A. Provide one (1) layer of 6 mil (0.15mm) polyethylene sheeting.

2.03 Perimeter Isolation

- A. Minimum 3/4"(20mm) thick PVC foam, density 7 lbs/ft³ average. PVC foam shall be Mason Industries P7.
- B. In seismic zone perimeter isolation shall be interspersed with 3/4"(20mm) thick, 60 durometer LDS bridge bearing pads the height of the perimeter material. Bridge bearing pad shall be made to the same AASHTO specifications, as shown for the FSN mountings and sized for a maximum deflection of 0.2"(5mm) at maximum earthquake forces. Interspersed pads shall be Mason Industries Type LDS-BBP.

2.04 Perimeter Caulking Compound

- A. Non-hardening, drying or bleeding. Troweling or pouring grade. Caulking compound shall be Mason Industries Type CC-75.

2.05 Floating Floor Drains

- A. Cast iron design. The upper funnel section cast into the floating floor. Lower bucket, built into the structure, shall retain water

surrounding the upper section as a between floors sound seal. Weep holes are required to drain the structural floor. Floor drains shall have water proofing membrane clamps. Floor drains shall be Mason Industries Type CFD-18591.

PART 3 - EXECUTION

3.01 Installation

Install the floating floor systems according to the installation and adjustment procedures and drawings submitted by the isolator manufacturer and approved by the architect.

The following table is a general guide to floor thicknesses and air gaps. All specifications may be modified to your requirements.

TYPICAL FLOOR CONFIGURATIONS

Air Gap	Floor Thickness	Overall Height
Most Common 2"	3" - Minimum	Air Gap Plus Floor Thickness
	4" - Most Common	
	5" - Seldom	
	6" - Common	
Occasionally 3" or 4"	Thicker Floors or Fractional Dimensions As Required. We have Designed Floating Floors 12" Thick.	

PRODUCT DETAILS

FSN LDS Jack-Up Mount

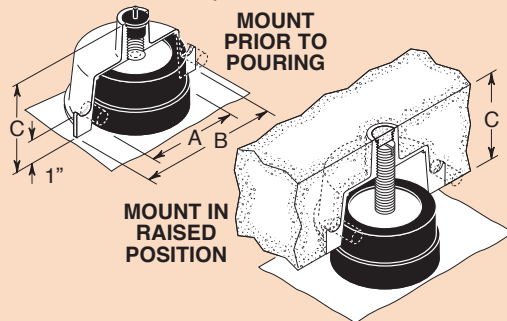

Load Range (lbs)	A (in)	B (in)	Min C (in)	Max C (in)
500 to 1700	45/8	51/2	3	As Reqd
2500 to 3500	53/8	61/4	3	As Reqd

Dynamic Frequency not to exceed 7.5 Hertz @ 0.3" Deflection. (60 Duro)

EAFM LDS Mount

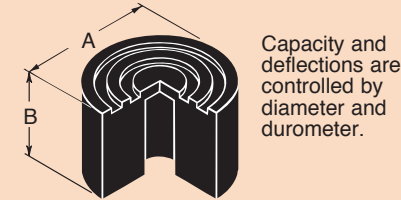

Load Range (lbs)	Typical Sizes		Max Defl 0.15T (in)	Lowest Dynamic Freq (Hz) 60 Duro
	A (in)	B (in)		
25 - 3500	1-3	1/2	0.08	15.0
lbs. per mount	1-4	1	0.15	11.0
as req'd	1.5-4.75	1 1/2	0.23	9.0
	2-5	2	0.30	7.5
	3-4.75	3	0.45	6.0
	4-5	4	0.60	5.5

Larger sizes can be molded as required or mountings clustered for greater capacity.

FS Spring Jack-Up Mount

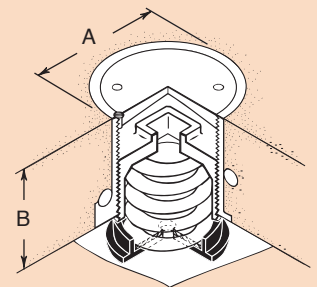

Load Range (lbs)	Defl (in)	A (in)	Min B (in)
450 to 1000	1	4	4
1000 to 2935	1	5	4
450 to 680	2	4	4
610 to 1870	2	5	4

P7 PVC Foam

Average Density: 7 lbs/cubic foot

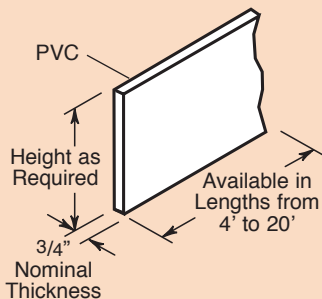

CFD Floor Drain

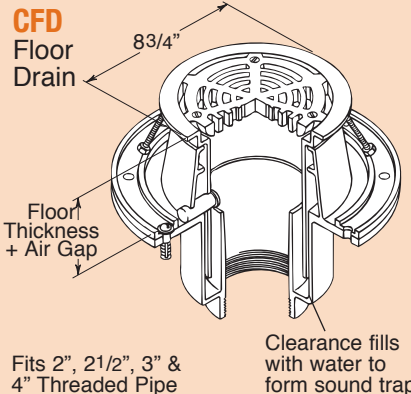

SFFS Seismic Floating Floor Snubber

SAB Anchor

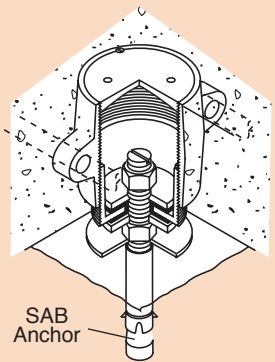



TV STUDIOS, THEATRES, etc. LDS JACK-UP SYSTEM beginning of specification

TYPICAL FLOOR WITHOUT MACHINERY

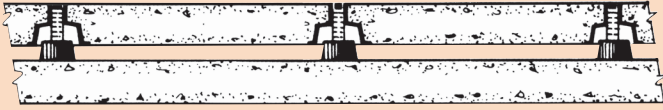

LDS JACK-UP SYSTEM FOR TV Studios, Theatres, Bowling Alleys, Kitchens, Squash Courts, Exercise Rooms, etc.

PART 1 - GENERAL

1.01 Description

We have left the blank below for you to fill in the name of the area, i.e. Auditorium, TV Studio, etc. Please specify floor finish such as hardwood or tile as you normally do in another section.

A. Scope of Work

1. Isolate floating floors from building structure by means of jack-up LDS isolators and perimeter isolation in each of the (fill in name of area) _____.

If sound barrier walls are used, add the following:

2. Build sound barrier walls on the floating floors.

B. Substitution of Materials

1. Substitute materials shall meet or exceed the "quality" of the products which are listed in these Specifications. Submit samples and test reports by an independent laboratory for consideration on this project.

1.02 Design

A. Intent

1. The floating floor system shall consist of a 4"(100mm) thick concrete slab isolated from and supported 2"(50mm) above the structural slab by resilient LDS isolators within cast iron housings designed to jack up the floor after pouring on the sub-floor. Sub floors shall be waterproofed under kitchens.

If sound barrier walls are used, add the following:

Sound barrier walls consisting of 6"(150mm) filled concrete block (Barrier wall construction can be changed when writing specification) shall rest on the floating floor with a 3 1/2"(90mm) air gap to the structural walls. (3 1/2"(90mm) may be reduced to 2"(50mm) if no sway braces are needed.)

2. The floating floor slab shall be isolated from adjoining walls, columns and curbs by means of perimeter isolation.
3. Any floor drains, piping, conduit and duct penetrations must not short circuit the isolation system.
4. In seismic zones the floating floor shall be restrained horizontally by curbs or walls designed to withstand the horizontal seismic forces. Solid bridge bearing LDS pads shall be interspersed between perimeter isolation to withstand the seismic forces with a maximum deflection of 0.2"(5mm). When perimeter cannot be used for seismic constraint, intersperse horizontal restraints within floor system.

B. Performance Requirements

1. The floating floor system shall have a minimum rating of STC-79 and INR+17 as verified by an independent laboratory in prior tests.

C. Floor System Construction Procedure

1. The setting of all isolation materials and raising of the floor shall be performed by or under the supervision of the isolation manufacturer.
2. Set and waterproof any drains and lower pipe seals in keeping with waterproofing specifications.
3. Cement perimeter isolation around all walls, columns, curbs, etc.
- 3a. In seismic zones intersperse the perimeter isolation with bridge bearing quality LDS pads the thickness of the perimeter isolation.
4. Cover entire floor area with 6 mil (0.15mm) plastic sheeting and carry sheeting up perimeter isolation.
5. Place bell-shaped castings on maximum 54"(1370mm) centers in the general areas in strict accordance with the approved drawings prepared by the isolation manufacturer. Additional reinforcement must be detailed on isolation manufacturer's drawings when required.

If sound barrier walls are used, add the following:

Perimeter isolators shall be selected to support the wall weight in addition to the perimeter of the floating floor.

6. Place reinforcing as shown on the drawings and pour floor monolithically.
7. Raise floor 2"(50mm) by means of the jack-screws.

8. Caulk perimeter isolation in all locations and grout jack-screw holes.

If sound barrier walls are used, add the following:

9. Construct block walls on the floating floor being careful that mortar does not drop behind the walls. Place 2"(50mm) fiberglass bats against the structural wall as a precaution. Provide sway braces and isolated angle iron wall braces at the top of the walls. Caulk angle iron braces.

D. Submittals

1. Detailed product drawings and Load/Deflection curves of all isolators.
2. AASHTO Test Reports on all properties in table 2.01 A from an accredited independent laboratory for all rubber durometers used.
3. Dynamic stiffness test from an accredited independent laboratory at 5, 10 and 15 Hz, showing dynamic stiffness does not exceed 1.4.
- 3a. Isolation frequency not to exceed 9 Hz at stated deflection.
4. Acoustical test data from an independent laboratory showing a minimum STC of 79 and a minimum INR of 17 using a 4"(100mm) concrete floating floor, a 6"(150mm) structural floor and a 2"(50mm) air gap.
5. A drawing or drawings showing:
 - a. Dead, live and concentrated loads.
 - b. Isolator sizes, deflections, frequencies and locations.
If sound barrier walls are used, add:
wall sway brace and isolated angle iron brace sizes, locations and frequencies.
 - c. Any drains or other penetrations.
 - d. Size, type, elevation and spacing of concrete reinforcement.
 - e. Caulking details.
 - f. Floating floor and wall construction procedure.

1.03 Quality Assurance

- A. Floating floor system components shall be designed and fabricated by a manufacturer with at least ten years experience in one hundred similar installations.
- B. The floating floor isolation materials shall be installed and the floor raised by or under the supervision of the isolator manufacturer.

1.04 Site Conditions

- A. If site conditions are unsatisfactory or raise questions about the installation of the floating floor, the work will not proceed until the condition has been corrected in a manner acceptable to the isolation manufacturer. The sub-floor must have the same pitch as the top of the floating floor or special provisions made for isolator housings of different height.

1.05 Sequencing and Scheduling

Coordinate work with other trades and coordinate scheduling with the construction supervisor to minimize delays.

PART 2 - PRODUCTS

2.01 Isolators

- A. Bell shaped castings with integral lugs to locate reinforcing, shrouding 2"(50mm) thick LDS isolators molded to the following AASHTO bridge bearing specifications. All housings shall have 3/4"(20mm) minimum diameter jackscrews. Deflections shall not exceed 0.3"(7.5mm) nor the frequency 10Hz. Isolators shall be Mason Industries type FSN.

Table 1. AASHTO BRIDGE BEARING SPECIFICATIONS FOR POLYISOPRENE

ORIGINAL PHYSICAL PROPERTIES	TESTED FOR AGING						COMPRES- SION SET	LONG TERM CREEP
	OVEN AGING(70hrs/158°F)			OZONE				
Tests: ASTM D-2240 & D-412	ASTM D-573		ASTM D-1149			ASTM D-395	ISO8013	
Duro- meter Shore A	Tensile Strength (min)	Elongat. at Break (min)	Hard- ness (max)	Tensile Strength (max)	Elongat. at Break (max)	25 pphm in air by Vol. 20% Strain 100°F	22hrs/158°F Method B	168hrs
40±5	2000 psi	500%	+10%	-25%	-25%	No Cracks	25%(max)	5%(max)
50±5	2250 psi	450%	+10%	-25%	-25%	No Cracks	25%(max)	5%(max)
60±5	2250 psi	400%	+10%	-25%	-25%	No Cracks	25%(max)	5%(max)
70±5	2250 psi	300%	+10%	-25%	-25%	No Cracks	25%(max)	5%(max)

NOTE: 40 Durometer is not included in AASHTO Specifications. Numbers are Mason standard.

If sound barrier walls are used, add the following:

- B. Wall Sway Braces: Double acting LDS sway braces with a fail safe feature in three planes. Braces shall be furnished with a bracket for bolting to the structural wall and a hooked end for insertion in the masonry joint. Braces shall have a frequency not



TV STUDIOS, THEATRES, etc. LDS JACK-UP SYSTEM specification concluded LDS JACK-UP SYSTEM for ROOFS beginning of specification

in excess of 10Hz based on the weight of the wall area per brace and a vertical stiffness not in excess of 50% of the horizontal. Sway braces shall be Mason Industries Type DNSB.

- C. Angle Brackets: 1 1/2"(40mm) x 2"(50mm) angle iron sections with provision for bolting to the structure and a minimum thickness of 3/8"(9mm) sponge cemented to the vertical leg. Angle Brackets shall be Mason Industries AB-716.

2.02 Bond Breaker Material

- A. Provide one (1) layer of 6 mil (0.15mm) polyethylene sheeting.

2.03 Perimeter Isolation

- A. Minimum 3/4"(20mm) thick PVC foam, density 7 lbs/ft³ average. PVC foam shall be Mason Industries P7.
- B. In seismic zone perimeter isolation shall be interspersed with 3/4"(20mm) thick, 60 durometer LDS bridge bearing pads the height of the perimeter material. Bridge bearing pad shall be made to the same AASHTO specifications, as shown for the FSN mountings and sized for a maximum deflection of 0.2"(5mm) at maximum earthquake forces. Interspersed pads shall be Mason Industries Type LDS-BBP.

2.04 Perimeter Caulking Compound

- A. Non-hardening, drying or bleeding. Troweling or pouring grade. Caulking compound shall be Mason Industries Type CC-75.

2.05 Floating Floor Drains

- A. Cast iron design. The upper funnel section cast into the floating floor. Lower bucket, built into the structure, shall retain water surrounding the upper section as a between floors sound seal. Weep holes are required to drain the structural floor. Floor drains shall have water proofing membrane clamps. Floor drains shall be Mason Industries Type CFD-18591.

PART 3 - EXECUTION

3.01 Installation

Install the floating floor systems according to the installation and adjustment procedures and drawings submitted by the isolator manufacturer and approved by the architect.

————— End of Specification —————

LDS JACK-UP SYSTEM FOR ROOFS.

PART 1 - GENERAL

1.01 Description

A. Scope of Work

1. Isolate floating roofs from the building structure by means of jack-up LDS isolators and perimeter isolation in each of the roof areas shown on the drawings.

If sound barrier walls are used, add the following:

2. Build sound barrier walls on the floating floors.

B. Substitution of Materials

1. Substitute materials shall meet or exceed the "quality" of the products which are listed in these Specifications. Submit samples and test reports by an independent laboratory for consideration on this project.

1.02 Design

A. Intent

1. The floating roof system shall consist of a 4"(100mm) waterproofed concrete slab isolated and supported 2"(50mm) above the waterproofed structural slab by resilient LDS isolators within cast iron housings designed to jack up the roof after pouring on the sub-roof.

If sound barrier walls are used, add the following:

Sound barrier walls consisting of 6"(150mm) filled concrete block (Barrier wall construction can be changed when writing specification) shall rest on the floating floor.

2. The floating roof slab shall be isolated from adjoining walls, columns, and curbs by means of perimeter isolation.
3. Any equipment mounted directly on the floating roof shall be installed so as not to damage the roof's waterproofing.
4. Flashing and waterproofing shall be completed after the roof is raised. Perimeter flashing shall allow for downward movement of 0.5"(12mm).

5. In seismic zones the floating floor shall be restrained horizontally by curbs or walls designed to withstand the horizontal seismic forces. Solid bridge bearing LDS pads shall be interspersed between perimeter isolation to withstand the seismic forces with a maximum deflection of 0.2"(5mm). When perimeter cannot be used for seismic constraint, intersperse horizontal restraints within floor system.

6. In seismic zones 2, 3 and 4 or equivalent Av, the roof shall be protected by embedded double acting resilient floor snubbers set in opposition to the overturning moments at the equipment snubbers in all locations where the center of gravity of major equipment is high.

B. Performance Requirements

1. The floating roof system shall have a minimum rating of STC-79 and INR+17 as verified by an independent laboratory in prior tests.

C. Roof System Construction Procedure

1. The setting of all isolation materials and raising of the roof shall be performed by or under the supervision of the isolation manufacturer.
2. Set and waterproof any drains and lower pipe seals in keeping with waterproofing specifications.
3. Cement perimeter isolation around all walls, columns, curbs, etc.
- 3a. In seismic zones intersperse the perimeter isolation with bridge bearing quality LDS pads the thickness of the perimeter isolation.
4. Cover entire floor area with 6 mil (0.15mm) plastic sheeting and carry sheeting up perimeter isolation.
5. Place bell-shaped castings on maximum 54"(1370mm) centers in the general areas in strict accordance with the approved drawings prepared by the isolation manufacturer. Spacing can be increased to straddle machinery locations. Additional reinforcement must be detailed on isolation manufacturer's drawings when required.

If sound barrier walls are used, add the following:

Perimeter isolators shall be selected to support the wall weight in addition to the perimeter of the floating roof.

- 5a. In seismic zones attach double acting resilient seismic snubbers to the structural slab on either side of high center of gravity equipment to withstand the overturning moment generated by the machinery snubbers and prevent failure of the floating roof.
6. Place reinforcing as shown on the drawings and pour roof monolithically.
7. Raise roof 2"(50mm) by means of the jack-screws. (If construction sequence dictates raising the roof before placing machinery, heavy planking must be used to protect the roof if machinery is rolled into position).
8. Caulk perimeter isolation in all locations and grout jack-screw holes.

If sound barrier walls are used, add the following:

9. Construct block walls on the floating floor being careful that mortar does not drop behind the walls. Place 2"(50mm) fiberglass bats against the structural wall as a precaution. Provide sway braces and isolated angle iron wall braces at the top of the walls. Caulk angle iron braces.
10. In seismic zones adjust the double acting snubbers after machinery is in place to provide a maximum up and down clearance of 0.125"(3mm).
11. Install waterproofing and flashing.

D. Submittals

1. Detailed product drawings and Load/Deflection curves of all isolators and in seismic zones double acting floor snubbers.
2. AASHTO Test Reports on all properties in table 2.01 A from an accredited independent laboratory for all rubber durometers used.
3. Dynamic stiffness test from an accredited independent laboratory at 5, 10 and 15 Hz, showing dynamic stiffness does not exceed 1.4.
- 3a. Isolation frequency not to exceed 9 Hz at stated deflection.
4. Acoustical test data from an independent laboratory showing a minimum STC of 79 and a minimum INR of 17 using a 4"(100mm) concrete floating floor, a 6"(150mm) structural floor and a 2"(50mm) air gap.
5. A drawing or drawings showing:
 - a. Dead, live and concentrated loads.
 - b. Isolator sizes, deflections, frequencies and locations and in seismic zones, locations of seismic snubbers.
 - c. Any drains or other penetrations.
 - d. Size, type, elevation and spacing of concrete reinforcement.
 - e. Caulking details.
 - f. Roof system construction procedure.



LDS JACK-UP SYSTEM for ROOFS specification concluded SPRING JACK-UP SYSTEM beginning of specification

1.03 Quality Assurance

- A. Floating roof system components shall be designed and fabricated by a manufacturer with at least ten years experience in one hundred similar floor or roof installations.
- B. The floating roof isolation materials shall be installed and the roof raised by or under the supervision of the isolator manufacturer.

1.04 Site Conditions

- A. If site conditions are unsatisfactory or raise questions about the installation of the floating roof, the work will not proceed until the condition has been corrected in a manner acceptable to the isolation manufacturer. The sub-roof must have the same pitch as the top of the floating roof or special provisions made for isolator housings of different height.

1.05 Sequencing and Scheduling

Coordinate work with other trades and coordinate scheduling with the construction supervisor to minimize delays.

PART 2 - PRODUCTS

2.01 Isolators

- A. Bell shaped castings with integral lugs to locate reinforcing, shrouding 2"(50mm) thick LDS isolators molded to the following AASHTO bridge bearing specifications. All housings shall have 3/4"(20mm) minimum diameter jackscrews. Deflections shall not exceed 0.3"(7.5mm) nor the frequency 10Hz. Isolator shall be Mason Industries type FSN.

Table 1. AASHTO BRIDGE BEARING SPECIFICATIONS FOR POLYISOPRENE

ORIGINAL PHYSICAL PROPERTIES			TESTED FOR AGING			COMPRES- SION SET	LONG TERM CREEP	
Tests: ASTM D-2240 & D-412			OVEN AGING(70hrs/158°F)					
Duro- meter	Tensile Strength at Break	Elongat. (min)	Hard- ness (max)	Tensile Strength at Break (max)	Elongat. (max)	ASTM D-1149 25 pphm in air by Vol. 20% Strain 100°F	ASTM D-395 22hrs/158°F Method B	ISO8013 168 hrs
40±5	2000 psi	500%	+10%	-25%	-25%	No Cracks	25%(max)	5%(max)
50±5	2250 psi	450%	+10%	-25%	-25%	No Cracks	25%(max)	5%(max)
60±5	2250 psi	400%	+10%	-25%	-25%	No Cracks	25%(max)	5%(max)
70±5	2250 psi	300%	+10%	-25%	-25%	No Cracks	25%(max)	5%(max)

NOTE: 40 Durometer is not included in AASHTO Specifications. Numbers are Mason standard.

- B. In seismic zones double acting resilient cast in floating floor snubbers shall consist of a ductile iron housing locked into the floating floor. The housing shall have a removable cover plate to provide access to the adjustment of clearances in both the up and down directions of the resilient stops. Resilient stops shall be attached to a restraining bolt attached to the structural floor with an approved anchor. Double acting snubbers shall be Mason Industries Type SFFS.

2.02 Bond Breaker Material

- A. Provide one (1) layer of 6 mil (0.15mm) polyethylene sheeting.

2.03 Perimeter Isolation

- A. Minimum 3/4"(20mm) thick PVC foam, density 7 lbs/ft³ average. PVC foam shall be Mason Industries P7.
- B. In seismic zone perimeter isolation shall be interspersed with 3/4"(20mm) thick, 60 durometer LDS bridge bearing pads the height of the perimeter material. Bridge bearing pad shall be made to the same AASHTO specifications, as shown for the FSN mountings and sized for a maximum deflection of 0.2"(5mm) at maximum earthquake forces. Interspersed pads shall be Mason Industries Type LDS-BBP.

2.04 Perimeter Caulking Compound

- A. Non-hardening, drying or bleeding. Troweling or pouring grade. Caulking compound shall be Mason Industries Type CC-75.

2.05 Floating Roof Drains

- A. Use standard roof drains cast into the floating roof. The structural floor shall have openings large enough to access pipe connections to the drains. Drain piping shall be suspended from combination spring and LDS hangers with a minimum of 1"(25mm) static deflection for 40 feet(12 meters) from the attachment point as shown on the drawings.
- B. Roof drains shall be (Architects Preference)

PART 3 - EXECUTION

3.01 Installation

Install the floating roof systems according to the installation and adjustment procedures and drawings submitted by the isolator manufacturer and approved by the architect.

TYPICAL SPRING CROSS SECTION

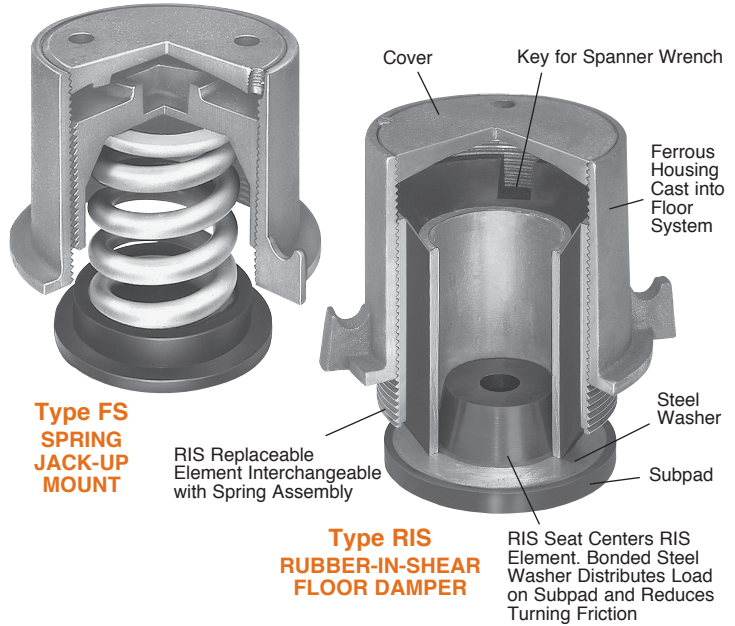
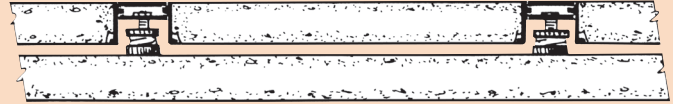

Type FS
SPRING
JACK-UP
MOUNT

Type RIS
RUBBER-IN-SHEAR
FLOOR DAMPER

The damping provided by the air under spring supported floors is normally adequate to limit motion. Occasionally, particularly in small aerobic rooms, rhythmic exercises amplify floor motion so additional damping is desirable. The RIS (rubber-in-shear) element solves this problem. Elements are interchangeable with FS springs and can be installed in existing housings if needed or included in the design stage in supplementary locations. Damping rate is controlled by hardness, material and number of dampers.

SPRING JACK-UP SYSTEM FOR TV STUDIOS, THEATRES, BOWLING ALLEYS, KITCHENS, SQUASH COURTS, EXERCISE ROOMS, ETC.

PART 1 - GENERAL

1.01 Description

A. Scope of Work

1. Isolate floating floors from the building structure by means of jack-up spring isolators and perimeter isolation in each of the _____ rooms as shown on the drawings. (Architect to fill in name of room.)

If sound barrier walls are used, add the following:

2. Build sound barrier walls on the floating floors.

B. Substitution of Materials

1. Substitute materials shall meet or exceed the "quality" of the products which are listed in these Specifications. Submit samples for consideration on this project.

1.02 Design

A. Intent

1. The floating floor system shall consist of a 4"(100mm) thick concrete slab isolated from and supported 2"(50mm) above the structural slab by resilient spring isolators within cast iron housings designed to jack up the floor after pouring on the sub-floor.

If sound barrier walls are used, add the following:

Sound barrier walls consisting of 6"(150mm) filled concrete block (Barrier wall construction may be changed by the architect when writing specification) shall rest on the floating floor with a 3/2"(90mm) air gap to the structural walls. (3"(90mm) may be reduced to 2"(50mm) if no sway braces are needed.)

2. The floating floor slab shall be isolated from adjoining walls and curbs by means of perimeter isolation.



SPRING JACK-UP SYSTEM specification concluded

3. Any floor drains, piping, conduit and duct penetrations must not short circuit the isolation system.
4. In seismic zones the floating floor shall be restrained horizontally by curbs or walls designed to withstand the horizontal seismic forces. Solid bridge bearing LDS pads shall be interspersed between perimeter isolation to withstand the seismic forces with a maximum deflection of 0.2"(5mm). When perimeter cannot be used for seismic constraint, intersperse horizontal restraints within floor system.

B. Performance Requirements

1. All spring isolators shall have the minimum specified deflection.

C. Floor System Construction Procedure

1. The setting of all isolation materials and raising of the floor shall be performed by or under the supervision of the isolation manufacturer.
2. Set and waterproof any drains and lower pipe seals in keeping with waterproofing specifications.
3. Cement perimeter isolation around all walls, columns, curbs, etc.
- 3a. In seismic zones intersperse the perimeter isolation with bridge bearing quality LDS pads the thickness of the perimeter isolation.
4. Cover entire floor area with 6 mil (0.15mm) polyethylene sheeting and carry sheeting up perimeter isolation.
5. Place spring isolator castings on a maximum of 54"(1370mm) centers in the general areas in strict accordance with the approved drawings prepared by the isolation manufacturer. Additional reinforcement such as in wall locations must be detailed on isolation manufacturer's drawings when required.

If sound barrier walls are used, add the following:

Perimeter isolators shall be selected to support the wall weight in addition to the perimeter of the floating floor.

6. Place reinforcing as shown on the drawings and pour floor monolithically.
7. Raise floor 2"(50mm) by means of the isolator threaded sleeves and replace covers.
8. Caulk perimeter isolation in all locations.

If sound barrier walls are used, add the following:

9. Construct block walls on the floating floor being careful that mortar does not drop behind the walls. Place 2"(50mm) fiberglass bats against the structural wall as a precaution. Readjust perimeter isolators as required to compensate for wall weight as the wall is built. Provide sway braces and isolated angle iron wall braces at the top of the walls. Caulk angle iron braces.

D. Submittals

1. Detailed product drawings including Load/Deflection curves of all isolators.
2. Drawing or drawings showing:
 - a. Dead, live and concentrated loads.
 - b. Isolator sizes, deflections and locations.

If sound barrier walls are used, add the following to b:

Wall sway brace and isolated angle iron brace locations.
 - c. Any drain and penetration locations.
 - d. Size, type, elevation and spacing of concrete reinforcement.
 - e. Caulking details.
 - f. Floating floor and wall construction procedure.

1.03 Quality Assurance

- A. Floating floor system components shall be designed and fabricated by a manufacturer with at least ten years experience in one hundred similar installations.
- B. The floating floor isolation materials shall be installed and the floor raised by or under the supervision of the isolator manufacturer.

1.04 Site Conditions

- A. If site conditions are unsatisfactory or raise questions about the installation of the floating floor, the work will not proceed until the condition has been corrected in a manner acceptable to the isolation manufacturer. The sub-floor must have the same pitch as the top of the floating floor or special provisions made for isolator housings of different height.

1.05 Sequencing and Scheduling

Coordinate work with other trades and coordinate scheduling with the construction supervisor to minimize delays.

PART 2 - PRODUCTS

2.01 Isolators

- A. Casting or weldments consisting of an internally threaded outer housing complete with lugs to support the reinforcing system. The inner inverted cup shaped housing shall be externally threaded. The springs are compressed and the floor lifted by turns of the internal housing. Springs shall be seated in neoprene cups and housings shall have removable cover plates. Spring diameters shall be no less than 0.8 of the compressed height of the spring at rated load. Springs shall have a minimum additional travel to solid equal to 50% of the rated deflection. Spring deflections shall be a minimum of 0.75"(20mm). (Note to architect: Deflections may be changed as required.) Isolators shall be Mason Industries Type FS.

If sound barrier walls are used, add the following:

- B. Wall Sway Braces: Double acting LDS sway braces with a fail safe feature in three planes. Braces shall be furnished with a bracket for bolting to the structural wall and a hooked end for insertion in the masonry joint. Braces shall have a frequency not in excess of 10Hz based on the weight of the wall area per brace and a vertical stiffness not in excess of 50% of the horizontal. Sway Braces shall be Mason Industries Type DNSB.
- C. Angle Brackets: 11/2"(40mm) x 2"(50mm) angle iron sections with provision for bolting to the structure and a minimum thickness of 3/8"(9mm) sponge cemented to the vertical leg. Angle Brackets shall be Mason Industries Type AB-716.

2.02 Bond Breaker Material

- A. Provide one (1) layer of 6 mil (0.15mm) polyethylene sheeting.

2.03 Perimeter Isolation

- A. Minimum 3/4"(20mm) thick PVC foam, density 7 lbs/ft³ average. PVC foam shall be Mason Industries P7.
- B. In seismic zone perimeter isolation shall be interspersed with 3/4"(20mm) thick, 60 durometer LDS bridge bearing pads the height of the perimeter material. Bridge bearing pad shall be made to AASHTO specifications, as shown and sized for a maximum deflection of 0.2"(5mm) at maximum earthquake forces. Interspersed pads shall be Mason Industries Type LDS-BBP.

Table 1. AASHTO BRIDGE BEARING SPECIFICATIONS FOR POLYISOPRENE

ORIGINAL PHYSICAL PROPERTIES	TESTED FOR AGING			COMPRESSION SET	LONG TERM CREEP	
	OVEN AGING (70hrs/158°F)	OZONE	ASTM D-1149			
Tests: ASTM D-2240 & D-412	ASTM D-573			ASTM D-395	ISO8013	
Duro- meter Strength at Break Shore A	Tensile Strength (min)	Elongat. at Break (min)	Hard- ness (max)	25 pphm in air by Vol. 20% Strain 100°F	22hrs/158°F Method B	168hrs
40±5	2000 psi	500%	+10% -25% -25%	No Cracks	25%(max)	5%(max)
50±5	2250 psi	450%	+10% -25% -25%	No Cracks	25%(max)	5%(max)
60±5	2250 psi	400%	+10% -25% -25%	No Cracks	25%(max)	5%(max)
70±5	2250 psi	300%	+10% -25% -25%	No Cracks	25%(max)	5%(max)

NOTE: 40 Durometer is not included in AASHTO Specifications. Numbers are Mason standard.

2.04 Perimeter Caulking Compound

- A. Non-hardening, drying or bleeding. Troweling or pouring grade. Caulking compound shall be Mason Industries Type CC-75.

2.05 Floating Floor Drains

- A. Cast iron design. The upper funnel section cast into the floating floor. Lower bucket, built into the structure, shall retain water surrounding the upper section as a between floors sound seal. Weep holes are required to drain the structural floor. Floor drains shall have water proofing membrane clamps. Floor drains shall be Mason Industries Type CFD-18591.

PART 3 - EXECUTION

3.01 Installation

Install the floating floor systems according to the installation and adjustment procedures and drawings submitted by the isolator manufacturer and approved by the architect.

Note to Architect: When theatres have sharply sloped floors, FSN or FS mountings must be furnished with round cast iron or neoprene wedges at each FSN or FS location so mountings are installed level. In extreme cases a restraining curb is needed at the base of the slope or the end of the straight section adjoining the slope.



MECHANICAL EQUIPMENT ROOM LDS FORM-WORK SYSTEM beginning of specification

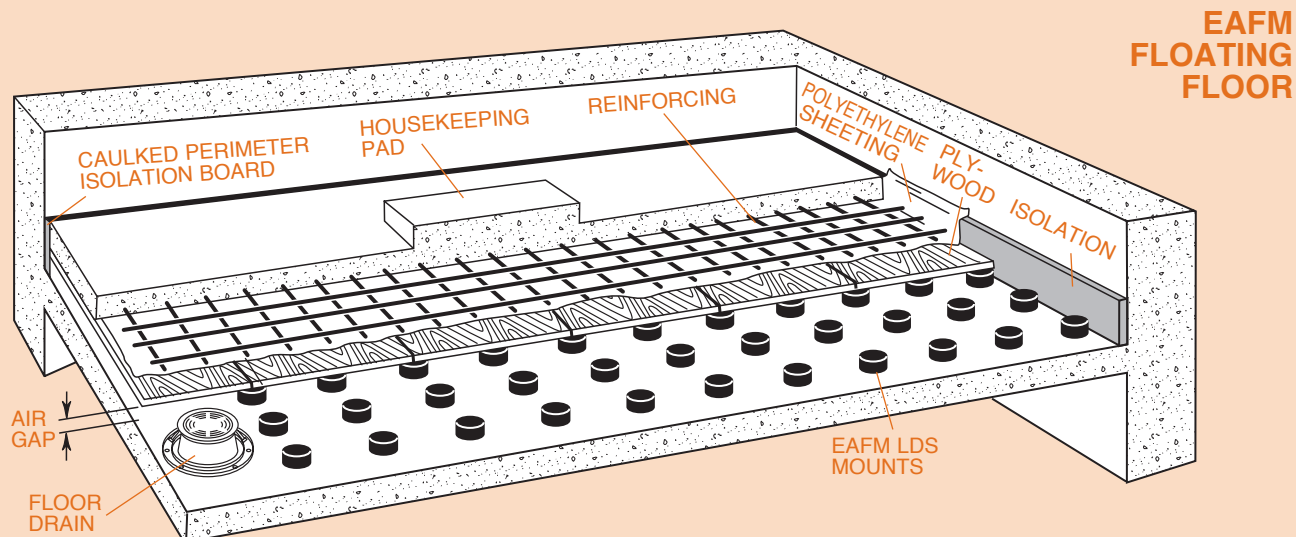

**EAFM
FLOATING
FLOOR**



**Type CFDA4 x 4
FLOOR DRAIN**



**Type EAFM
LDS FLOOR MOUNT**

LDS FORM-WORK SYSTEM FOR MECHANICAL EQUIPMENT ROOMS WITH MACHINERY SUPPORTED BY THE FLOATING FLOOR.

PART 1 - GENERAL

1.01 Description

A. Scope of Work

1. Isolate floating floors from building structure by means of LDS isolators under plywood panels and perimeter isolation in mechanical equipment rooms as shown on the drawings.

If sound barrier walls are used, add the following:

2. Build sound barrier walls on the floating floors.

B. Substitution of Materials

1. Substitute materials shall meet or exceed the "quality" of the products which are listed in these Specifications. Submit samples and test reports by an independent laboratory for consideration on this project.

1.02 Design

A. Intent

1. The floating floor shall consist of a 4" (100mm) thick concrete slab isolated from and supported 2 1/2" (62mm) above the waterproofed structural slab by resilient LDS isolators covered by 1/2" (12mm) plywood panels that form the pouring surface.

If sound barrier walls are used, add the following:

Sound barrier walls consisting of 6" (150mm) filled concrete block (Barrier wall construction may be changed by architect when writing specification) shall rest on the floating floor with a 3 1/2" (90mm) air gap to the structural walls. (3 1/2" (90mm) may be reduced to 2" (50mm) if no sway braces are needed.)

2. The floating floor slab shall be isolated from adjoining walls and curbs by means of perimeter isolation.
3. Any floor drains, piping, conduit and duct penetrations must not short circuit the isolation system.
4. Any equipment within these rooms shall be mounted on housekeeping pads or directly on the floating floor as shown on the drawings.
5. In seismic zones the floating floor shall be restrained horizontally by curbs or walls designed to withstand the horizontal seismic forces. Solid bridge bearing LDS pads shall be interspersed between perimeter isolation to withstand the seismic forces with a maximum deflection of 0.2" (5mm). When perimeter cannot be used for seismic constraint, intersperse horizontal restraints within floor system.
6. In seismic zones 2, 3 and 4 or equivalent Av, the floor shall be protected by embedded double acting resilient floor snubbers set in opposition to the overturning moments at the equipment snubbers in all locations where the center of gravity of major equipment is high.

B. Performance Requirements

1. The floating floor system shall have a minimum rating of STC-79 and INR+17 as verified by an independent laboratory in prior tests.

C. Floor System Construction Procedure

1. The setting of all isolation materials shall be performed by or under the supervision of the isolation manufacturer.
2. Set and waterproof any drains and lower pipe seals in keeping with waterproofing specifications.
3. Cement perimeter isolation around all walls, columns, curbs, etc.
- 3a. In seismic zones intersperse the perimeter isolation with bridge bearing quality LDS pads the thickness of the perimeter isolation.
4. Place individual LDS isolators on the sub-floor at a maximum spacing of 24" (600mm) in strict accordance with the approved drawings prepared by the isolation manufacturer. Additional reinforcement must be detailed on isolation manufacturer's drawings when required.

If sound barrier isolation walls are used, add the following:

Perimeter isolators shall be selected to support the wall weight in addition to the perimeter of the floating floor.

5. In seismic zones provide anchorage for the double acting resilient vertical snubbers to the structural slab. Snubber anchor bolts must be in close proximity to the mechanical snubbers restraining any high center of gravity equipment to withstand the overturning moments generated by the machinery snubbers and prevent failure of the floating floor.
6. Cover isolators with 1/2" (12mm) AC plywood. Isolators shall be located under joints and joints staggered. Connect plywood at abutting edges and corners with 16 gauge steel junction plates.
7. Cover the plywood with 6 mil (0.15mm) plastic sheeting and carry it up the walls past the perimeter isolation.
8. Place seismic snubber housings on the anchor bolts that protrude from the structural floor and through the plywood.
9. Place reinforcing as shown on the drawings and pour floor monolithically.



MECHANICAL EQUIPMENT ROOM LDS FORM-WORK SYSTEM specification concluded

10. After the concrete has hardened, caulk all perimeter isolation.

If sound barrier walls are used, add the following:

Construct block walls on the floating floor being careful that mortar does not drop behind the walls. Place 2"(50mm) fiberglass bats against the structural wall as a precaution. Provide sway braces and isolated angle iron wall braces at the top of the walls. Caulk angle iron braces.

11. In seismic zones adjust the double acting snubbers after machinery is in place to provide a maximum up and down clearance of 0.125"(3mm).

D. Submittals

1. Detailed product drawings and Load/Deflection curves of all isolators. In seismic zones details of double acting floor snubbers.
2. AASHTO Test Reports on all properties in table 2.01 A from an accredited independent laboratory for all rubber durometers used.
3. Dynamic stiffness test from an accredited independent laboratory at 5, 10 and 15 Hz, showing dynamic stiffness does not exceed 1.4.
- 3a. Isolation frequency not to exceed 9 Hz at stated deflection.
4. Acoustical test data from an independent laboratory showing a minimum STC-79 and a minimum INR+17 using a 4"(100mm) concrete floating floor, a 6"(150mm) structural floor and 2"(50mm) air gap.
5. A drawing or drawings showing:
 - a. Dead, live and concentrated loads.
 - b. Isolators sizes, deflections, frequencies and locations. In seismic zones add: "Locations and details of seismic snubbers".

If sound barrier walls are used, add the following:

Wall sway brace and isolator, angle iron brace sizes, locations and frequencies.

- c. Any drain and penetration locations.
- d. Size type elevation and spacing of concrete reinforcement.
- e. Caulking details.
- f. Floating floor and wall construction procedure.

1.03 Quality Assurance

- A. Floating floor system components shall be designed and fabricated by a manufacturer with at least ten years experience in one hundred similar installations.
- B. The floating floor isolation materials and panel board forms shall be installed under the supervision of the isolator manufacturer.

1.04 Site Conditions

- A. If site conditions are unsatisfactory or raise questions about the installation of the floating floor, the work will not proceed until the condition has been corrected in a manner acceptable to the isolation manufacturer.

1.05 Sequencing and Scheduling

Coordinate work with other trades and coordinate scheduling with the construction supervisor to minimize delays.

PART 2 - PRODUCTS

2.01 Isolators

- A. Cylindrical LDS mountings with a diameter no less than 0.9 of the 2"(50mm) height. Isolators are molded to the following LDS AASHTO bridge bearing specification. Maximum durometer 60. Deflections shall not exceed 0.3"(7.5mm) nor the frequency 10Hz. Isolators shall be Mason Industries Type EAFM.

Table 1. AASHTO BRIDGE BEARING SPECIFICATIONS FOR POLYISOPRENE

ORIGINAL PHYSICAL PROPERTIES	TESTED FOR AGING			COMPRESSION SET	LONG TERM CREEP			
	OVEN AGING(70hrs/158°F)	OZONE						
Tests: ASTM D-2240 & D-412	ASTM D-573	ASTM D-1149		ASTM D-395	ISO8013			
Duro-meter Strength at Break Shore A	Tensile Strength at Break (min)	Elongat. (min)	Hard-ness (max)	25 pphm in air by Vol. 20% Strain 100°F	22hrs/158°F Method B	168hrs		
40±5	2000 psi	500%	+10%	-25%	-25%	No Cracks	25%(max)	5%(max)
50±5	2250 psi	450%	+10%	-25%	-25%	No Cracks	25%(max)	5%(max)
60±5	2250 psi	400%	+10%	-25%	-25%	No Cracks	25%(max)	5%(max)
70±5	2250 psi	300%	+10%	-25%	-25%	No Cracks	25%(max)	5%(max)

NOTE: 40 Durometer is not included in AASHTO Specifications. Numbers are Mason standard.

- B. In seismic zones double acting resilient cast in floating floor snubbers shall consist of a ductile iron housing locked into the floating floor. The housing shall have a removable cover plate to provide access to the adjustment of resilient stop clearances in both the up and down directions. Resilient stops shall be attached to a

restraining bolt attached to the structural floor with an approved anchor. Double acting snubbers shall be Mason Industries Type SFFS.

If sound barrier walls are used, add the following:

- C. Wall Sway Braces: Double acting LDS sway braces with a fail safe feature in three planes. Braces shall be furnished with a bracket for bolting to the structural wall and a hooked end for insertion in the masonry joint. Braces shall have a frequency not in excess of 10Hz based on the weight of the wall area per brace and a vertical stiffness not in excess of 50% of the horizontal. Sway Braces shall be Mason Industries Type DNSB.
- D. Angle Brackets: 1 1/2"(40mm) x 2"(50mm) angle iron sections with provision for bolting to the structure and a minimum thickness of 3/8"(9mm) sponge cemented to the vertical leg. Angle Brackets shall be Mason Industries Type AB-716.

2.02 Plywood Covering Material

- A. Provide one (1) layer of 6 mil (0.15mm) polyethylene sheeting.

2.03 Perimeter Isolation

- A. Minimum 3/4"(20mm) thick PVC foam, density 7 lbs/ft³ average. PVC foam shall be Mason Industries P7.
- B. In seismic zone perimeter isolation shall be interspersed with 3/4"(20mm) thick, 60 durometer LDS bridge bearing pads the height of the perimeter material. Bridge bearing pad shall be made to the same AASHTO specifications, as shown for the EAFM mountings and sized for a maximum deflection of 0.2"(5mm) at maximum earthquake forces. Interspersed pads shall be Mason Industries Type LDS-BBP.

2.04 Perimeter Caulking Compound

- A. Non-hardening, drying or bleeding. Troweling or pouring grade. Caulking compound shall be Mason Industries Type CC-75.

2.05 Floating Floor Drains

- A. Cast iron design. The upper funnel section cast into the floating floor. Lower bucket, built into the structure, shall retain water surrounding the upper section as a between floors sound seal. Weep holes are required to drain the structural floor. Floor drains shall have water proofing membrane clamps. Floor drains shall be Mason Industries Type CFD-18591.

2.06 Plywood

- A. Type AC exterior grade 1/2"(12mm) thick.

PART 3 - EXECUTION

3.01 Installation

Install the floating floor systems according to the installation and adjustment procedures and drawings submitted by the isolator manufacturer and approved by the architect.

APPLICATION OF SEISMIC FLOATING FLOOR SNUBBERS

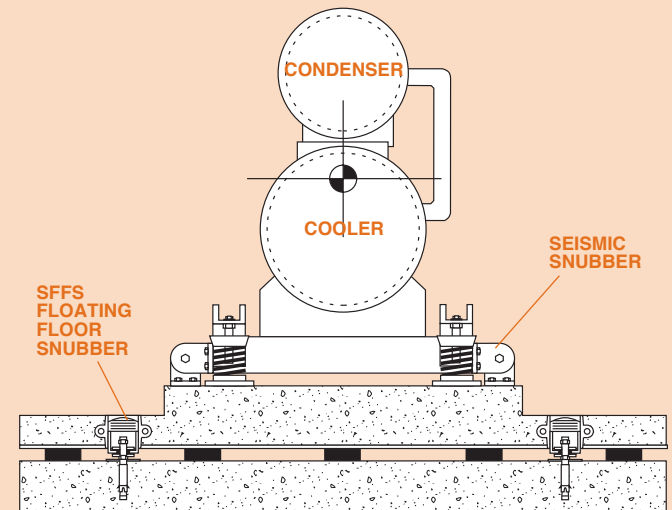

SNUBBER SHOWN WITH EAFM PANEL SYSTEM
Equally suitable for FSN Jack-Up Floors



TV STUDIOS, THEATRES, etc. LDS FORM-WORK SYSTEM beginning of specification

TYPICAL SLOPED THEATRE FLOOR

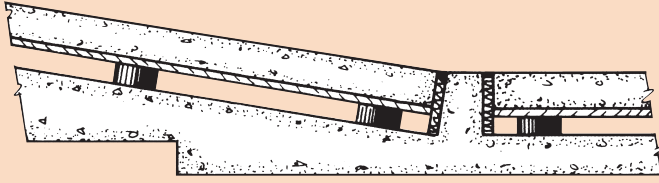

LDS FORM-WORK SYSTEM FOR TV STUDIOS, THEATRES, BOWLING ALLEYS, KITCHEN, SQUASH COURTS, EXERCISE ROOMS, ETC.

PART 1 - GENERAL

1.01 Description

A. Scope of Work

1. Isolate floating floors from building structure by means of LDS isolators under plywood panels and perimeter isolation in mechanical equipment rooms as shown on the drawings.

If sound barrier walls are used, add the following:

2. Build sound barrier walls on the floating floors.

B. Substitution of Materials

1. Substitute materials shall meet or exceed the "quality" of the products which are listed in these Specifications. Submit samples and test reports by an independent laboratory for consideration on this project.

1.02 Design

A. Intent

1. The floating floor shall consist of a 4" (100mm) thick concrete slab isolated from and supported 2 1/2" (62mm) above the waterproofed structural slab by resilient LDS isolators covered by plywood panels that form the pouring surface.

If sound barrier walls are used, add the following:

Sound barrier walls consisting of 6" (150mm) filled concrete block (Barrier wall construction may be changed by architect when writing specification) shall rest on the floating floor with a 3 1/2" (90mm) air gap to the structural walls. (3 1/2" (90mm) may be reduced to 2" (50mm) if no sway braces are needed.)

2. The floating floor slab shall be isolated from adjoining walls and curbs by means of perimeter isolation.
3. Any floor drains, piping, conduit and duct penetrations must not short circuit the isolation system.
4. Any equipment within these rooms shall be mounted on house-keeping pads or directly on the floating floor as shown on the drawings.
5. In seismic zones the floating floor shall be restrained horizontally by curbs or walls designed to withstand the horizontal seismic forces. Solid bridge bearing LDS pads shall be interspersed between perimeter isolation to withstand the seismic forces with a maximum deflection of 0.2" (5mm). When perimeter cannot be used for seismic constraint, intersperse horizontal restraints within floor system.

B. Performance Requirements

1. The floating floor system shall have a minimum rating of STC-79 and INR+17 as verified by an independent laboratory in prior tests.

C. Floor System Construction Procedure

1. The setting of all isolation materials shall be performed by or under the supervision of the isolation manufacturer.
2. Set and waterproof any drains and lower pipe seals in keeping with waterproofing specifications.
3. Cement perimeter isolation around all walls, columns, curbs, etc.
- 3a. In seismic zones intersperse the perimeter isolation with bridge bearing quality LDS pads the thickness of the perimeter isolation.
4. Place individual LDS isolators on the sub-floor at a maximum spacing of 24" (600mm) in strict accordance with the approved drawings prepared by the isolation manufacturer. Additional reinforcement must be detailed on isolation manufacturer's drawings when required.

If sound barrier isolation walls are used, add the following:

Perimeter isolators shall be selected to support the wall weight in addition to the perimeter of the floating floor.

5. Cover isolators with 1/2" (12mm) AC plywood. Isolators shall be located under joints and joints staggered. Connect plywood at abutting edges with plywood junction plates.
6. Cover the plywood with polyethylene sheeting and carry it up the walls past the perimeter isolation.
7. Place reinforcing as shown on the drawings and pour floor monolithically.
8. After the concrete has hardened, caulk all perimeter isolation.

If sound barrier walls are used, add 9.

9. Construct block walls on the floating floor being careful that mortar does not drop behind the walls. Place 2" (50mm) fiberglass bats against the structural wall as a precaution. Provide sway braces and isolated angle iron wall braces at the top of the walls. Caulk angle iron braces.

D. Submittals

1. Detailed product drawings and load /deflection curves of all isolators.
2. AASHTO Test Reports on all properties in table 2.01 A from an accredited independent laboratory for all rubber durometers used.
3. Dynamic stiffness test from an accredited independent laboratory at 5, 10 and 15 Hz, showing dynamic stiffness does not exceed 1.4.
- 3a. Isolation frequency not to exceed 9 Hz at stated deflection.
4. Acoustical test data from an independent laboratory showing a minimum STC-79 and a minimum INR+17 using a 4" (100mm) concrete floating floor, a 6" (150mm) structural floor and 2" (50mm) air gap.
5. A drawing or drawings showing:
 - a. Dead, live and concentrated loads.
 - b. Isolators sizes, deflections, frequencies and locations.
If sound barrier walls are used, add the following:
Wall sway brace and isolator, angle iron brace sizes, locations and frequencies.
 - c. Any drain and penetration locations.
 - d. Size type elevation and spacing of concrete reinforcement.
 - e. Caulking details.
 - f. Floating floor and wall construction procedure.

1.03 Quality Assurance

- A. Floating floor system components shall be designed and fabricated by a manufacturer with at least ten years experience in one hundred similar installations.
- B. The floating floor isolation materials and panel board forms shall be installed under the supervision of the isolator manufacturer.

1.04 Site Conditions

- A. If site conditions are unsatisfactory or raise questions about the installation of the floating floor, the work will not proceed until the condition has been corrected in a manner acceptable to the isolation manufacturer.

1.05 Sequencing and Scheduling

Coordinate work with other trades and coordinate scheduling with the construction supervisor to minimize delays.

PART 2 - PRODUCTS

2.01 Isolators

- A. Cylindrical LDS mountings with a diameter no less than 0.9 of the 2" (50mm) height. Isolators are molded to the following LDS AASHTO bridge bearing specification. Maximum durometer 60. Deflections shall not exceed 0.3" (7.5mm) nor the frequency 10Hz. Isolators shall be Mason Industries Type EAFM.

Table 1. AASHTO BRIDGE BEARING SPECIFICATIONS FOR POLYISOPRENE

ORIGINAL PHYSICAL PROPERTIES			TESTED FOR AGING			COMPRESSION SET ASTM D-395 22hrs/158°F Method B	LONG TERM CREEP ISO8013 168 hrs
Tests: ASTM D-2240 & D-412			ASTM D-573				
Duro- Shore A	Tensile Strength (min)	Elongat. at Break (min)	Hard- ness (max)	Tensile Strength (max)	Elongat. at Break (max)		
40±5	2000 psi	500%	+10%	-25%	-25%	No Cracks	5%(max)
50±5	2250 psi	450%	+10%	-25%	-25%	No Cracks	5%(max)
60±5	2250 psi	400%	+10%	-25%	-25%	No Cracks	5%(max)
70±5	2250 psi	300%	+10%	-25%	-25%	No Cracks	5%(max)

NOTE: 40 Durometer is not included in AASHTO Specifications. Numbers are Mason standard.



TV STUDIOS, THEATRES, etc. LDS FORM-WORK SYSTEM specification concluded LDS FORM-WORK SYSTEM for ROOFS beginning of specification

If sound barrier walls are used, add the following:

- B. Wall Sway Braces: Double acting LDS sway braces with a fail safe feature in three planes. Braces shall be furnished with a bracket for bolting to the structural wall and a hooked end for insertion in the masonry joint. Braces shall have a frequency not in excess of 10Hz based on the weight of the wall area per brace and a vertical stiffness not in excess of 50% of the horizontal. Sway Braces shall be Mason Industries Type DNSB.
- C. Angle Brackets: 1 1/2"(40mm) x 2"(50mm) angle iron sections with provision for bolting to the structure and a minimum thickness of 3/8"(9mm) sponge cemented to the vertical leg. Angle Brackets shall be Mason Industries Type AB-716.

2.02 Bond Breaker Material

- A. Provide one (1) layer of 6 mil (0.15mm) polyethylene sheeting.

2.03 Perimeter Isolation

- A. Minimum 3/4"(20mm) thick PVC foam, density 7 lbs/ft³ average. PVC foam shall be Mason Industries P7.
- B. In seismic zone perimeter isolation shall be interspersed with 3/4"(20mm) thick, 60 durometer LDS bridge bearing pads the height of the perimeter material. Bridge bearing pad shall be made to the same AASHTO specifications, as shown for the EAFM mountings and sized for a maximum deflection of 0.2"(5mm) at maximum earthquake forces. Interspersed pads shall be Mason Industries Type LDS-BBP.

2.04 Perimeter Caulking Compound

- A. Non-hardening, drying or bleeding. Troweling or pouring grade. Caulking compound shall be Mason Industries Type CC-75.

2.05 Floating Floor Drains

- A. Cast iron design. The upper funnel section cast into the floating floor. Lower bucket, built into the structure, shall retain water surrounding the upper section as a between floors sound seal. Weep holes are required to drain the structural floor. Floor drains shall have water proofing membrane clamps. Floor drains shall be Mason Industries Type CFD-18591.

2.06 Plywood

- A. Type AC exterior grade 1/2"(12mm) thick.

PART 3 - EXECUTION

3.01 Installation

Install the floating floor systems according to the installation and adjustment procedures and drawings submitted by the isolator manufacturer and approved by the architect.

————— End of Specification —————

LDS FORM-WORK SYSTEM FOR ROOFS

PART 1 - GENERAL

1.01 Description

- A. Scope of Work
 1. Isolate floating roofs from the building structure by means of LDS isolators under plywood panels and perimeter isolation as shown on the drawings.

If sound barrier walls are used, add the following:

2. Build sound barrier walls on the floating floors.
- B. Substitution of Materials
 1. Substitute materials shall meet or exceed the "quality" of the products which are listed in these Specifications. Submit samples and test reports by an independent laboratory for consideration on this project.

1.02 Design

- A. Intent
 1. The floating roof shall consist of a 4"(100mm) thick concrete slab isolated from and supported 2 1/2"(62mm) above the waterproof structural slab by resilient LDS isolators covered by plywood panels that form the pouring surface.

If sound barrier walls are used, add the following:

Sound barrier walls consisting of 6"(150mm) filled concrete block (Barrier wall construction can be changed when writing specification) shall rest on the floating floor.

2. The floating roof slab shall be isolated from adjoining walls and curbs by means of perimeter isolation.
3. Any floor drains, piping, conduit and duct penetrations must not short circuit the isolation system.
4. Any equipment on the roof shall be mounted on housekeeping pads or directly on the floating roofs as shown on the drawings, and installed so as not to damage the roof's waterproofing.
5. In seismic zones the floating floor shall be restrained horizontally by curbs or walls designed to withstand the horizontal seismic forces. Solid bridge bearing LDS pads shall be interspersed between perimeter isolation to withstand the seismic forces with a maximum deflection of 0.2"(5mm). When perimeter cannot be used for seismic constraint, intersperse horizontal restraints within floor system.
6. In seismic zones 2, 3 and 4 or equivalent Av, the floor shall be protected by embedded double acting resilient floor snubbers set in opposition to the overturning moments at the equipment snubbers in all locations where the center of gravity of major equipment is high.

B. Performance Requirements

1. The floating roof system shall have a minimum rating of STC 79 and INR+17 as verified by an independent laboratory in prior tests.

C. Roof System Construction Procedure

1. The setting of all isolation materials shall be performed by or under the supervision of the isolation manufacturer.
2. Set and waterproof any drains and lower pipe seals in keeping with waterproofing specifications.
3. Cement perimeter isolation around all walls, columns, curbs, etc.
- 3a. In seismic zones intersperse the perimeter isolation with bridge bearing quality LDS pads the thickness of the perimeter isolation.
4. Place individual LDS isolators on the sub-floor at a maximum spacing of 24"(600mm) in strict accordance with the approved drawings prepared by the isolation manufacturer. Additional reinforcement must be detailed on isolation manufacturer's drawings when required.

If sound barrier isolation walls are used, add the following:

Perimeter isolators shall be selected to support the wall weight in addition to the perimeter of the floating roof.

5. In seismic zones provide anchorage for the double acting resilient vertical snubbers to the structural slab. Snubber anchor bolts must be in close proximity to the mechanical snubbers restraining any high center of gravity equipment to withstand the overturning moments generated by the machinery snubbers and prevent failure of the floating floor.
6. Cover isolators with 1/2"(12mm) AC plywood. Isolators shall be located under joints and joints staggered. Connect plywood at abutting edges and corners with 16 gauge steel junction plates.
7. Cover the plywood with polyethylene sheeting and carry it up the walls past the perimeter isolation.
8. Place seismic snubber housings on anchor bolts that protrude from the structural floor and through the plywood.
9. Place reinforcing as shown on the drawings and pour floor monolithically.
10. After the concrete has hardened, caulk all perimeter isolation.

If sound barrier walls are used, add the following:

11. Construct block walls on the floating floor being careful that mortar does not drop behind the walls.
12. Perimeter roofing shall be done to allow for 0.5"(12mm) of downward movement without leakage.
13. In seismic zones adjust the double acting snubbers after machinery is in place to provide a maximum up and down clearance of 0.125"(3mm).

D. Submittals

1. Detailed product drawings and load /deflection curves of all isolators and in seismic zones double acting floor snubbers.
2. AASHTO Test Reports on all properties in table 2.01 A from an accredited independent laboratory for all rubber durometers used.
3. Dynamic stiffness test from an accredited independent laboratory at 5, 10 and 15 Hz, showing dynamic stiffness does not exceed 1.4.
- 3a. Isolation frequency not to exceed 9 Hz at stated deflection.
4. Acoustical test data from an independent laboratory showing a minimum STC of 79 and a minimum INR of 17 using a 4"(100mm) concrete floating floor, a 6"(150mm) structural floor and a 2"(50mm) air gap.



LDS FORM-WORK SYSTEM for ROOFS specification concluded

5. A drawing or drawings showing:
 - a. Dead, live and concentrated loads.
 - b. Isolator sizes, deflections, frequencies and locations and in seismic zones, locations of seismic snubbers.
 - c. Any drain and penetration locations.
 - d. Size, type, elevation and spacing of concrete reinforcement.
 - e. Caulking details.
 - f. Floating roof and wall construction procedure.

NOTE: 40 Durometer is not included in AASHTO Specifications. Numbers are Mason standard.

- B. In seismic zones double acting resilient cast in floating floor snubbers shall consist of a ductile iron housing locked into the floating floor. The housing shall have a removable cover plate to provide access to the adjustment of clearances in both the up and down directions of the resilient stops. Resilient stops shall be attached to a restraining bolt attached to the structural floor with an approved anchor. Double acting snubbers shall be Mason Industries Type SFFS.

1.03 Quality Assurance

- A. Floating roof system components shall be designed and fabricated by a manufacturer of at least ten years experience in one hundred similar floating floor installations.
- B. The floating roof isolation materials and panel board forms shall be installed under the supervision of the isolator manufacturer.

1.04 Site Conditions

- A. If site conditions are unsatisfactory or raise questions about the installation of the floating floor, the work will not proceed until the condition has been corrected in a manner acceptable to the isolation manufacturer. The sub-floor must have the same pitch as the top of the floating roof or special provisions made for isolator housings of different height.

1.05 Sequencing and Scheduling

Coordinate work with other trades and coordinate scheduling with the construction supervisor to minimize delays.

PART 2 - PRODUCTS

2.01 Isolators

- A. Cylindrical LDS mountings with a diameter no less than 0.9 of the 2" (50mm) height. Isolators are molded to the following LDS AASHTO bridge bearing specification. Maximum durometer 60. Deflections shall not exceed 0.3"(7.5mm) nor the frequency 10Hz. Isolators shall be Mason Industries Type EAFM.

Table 1. AASHTO BRIDGE BEARING SPECIFICATIONS FOR POLYISOPRENE

ORIGINAL PHYSICAL PROPERTIES	TESTED FOR AGING			COMPRESSION SET	LONG TERM CREEP			
	OVEN AGING(70hrs/158°F)							
Tests: ASTM D-2240 & D-412	ASTM D-573	ASTM D-1149	ASTM D-395	22hrs/158°F Method B	ISO8013			
Duro-meter Shore A	Hard-ness (max)	Tensile Strength (max)	Elongat. at Break (max)	25 pphm in air by Vol. 20% Strain 100°F	168 hrs			
40±5	2000 psi	500%	+10%	-25%	-25%	No Cracks	25%(max)	5%(max)
50±5	2250 psi	450%	+10%	-25%	-25%	No Cracks	25%(max)	5%(max)
60±5	2250 psi	400%	+10%	-25%	-25%	No Cracks	25%(max)	5%(max)
70±5	2250 psi	300%	+10%	-25%	-25%	No Cracks	25%(max)	5%(max)

2.02 Plywood Cover Material

- A. Provide one (1) layer of 6 mil (0.15mm) polyethylene sheeting over the plywood.

2.03 Perimeter Isolation

- A. Minimum 3/4"(20mm) thick PVC foam, density 7 lbs/ft³ average. PVC foam shall be Mason Industries P7.
- B. In seismic zone perimeter isolation shall be interspersed with 3/4"(20mm) thick, 60 durometer LDS bridge bearing pads the height of the perimeter material. Bridge bearing pad shall be made to the same AASHTO specifications, as shown for the EAFM mountings and sized for a maximum deflection of 0.2"(5mm) at maximum earthquake forces. Interspersed pads shall be Mason Industries Type LDS-BBP.

2.04 Perimeter Caulking Compound

- A. Non-hardening, drying or bleeding. Troweling or pouring grade. Caulking compound shall be Mason Industries Type CC-75.

2.05 Floating Roof Drains

- A. Floating roof drains shall be selected by the architect. A hole large enough to allow passage of the drain piping shall be left in the structural roof. Drain piping shall be suspended from combination spring and LDS hangers with a minimum of 1"(25mm) static deflection for 40 feet (12 meters) from the attachment point as shown on the drawings.
- B. Floor drains shall be (Architects preference).

2.06 Plywood

- A. Type AC exterior grade 1/2"(12mm) thick.

PART 3 - EXECUTION

3.01 Installation

Install the floating floor systems according to the installation procedures and drawings submitted by the isolator manufacturer and approved by the architect.

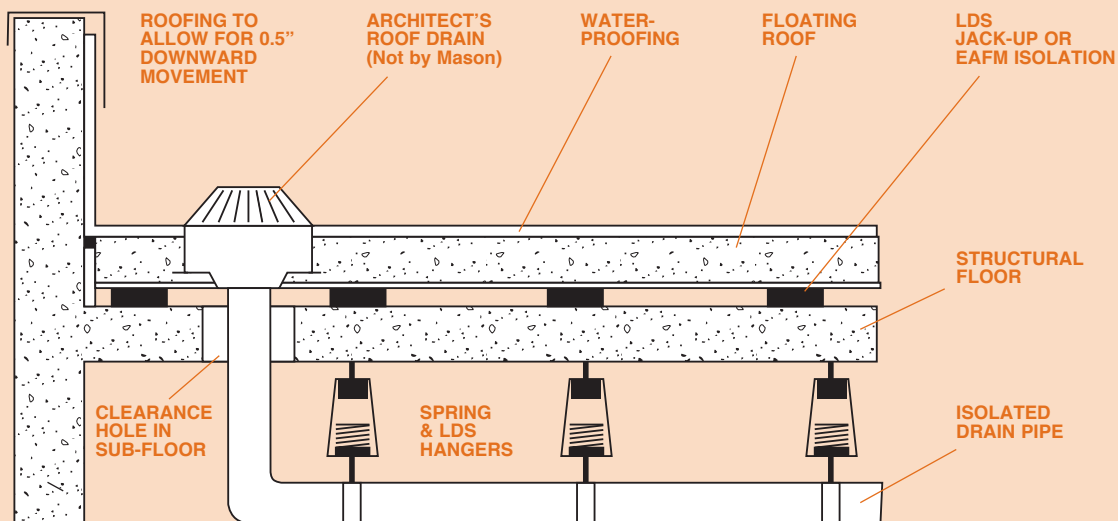

FSN JACK-UP OR EAFM PANEL SYSTEM USING STANDARD ROOF DRAIN

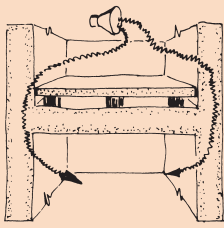

FLANKED FLOOR

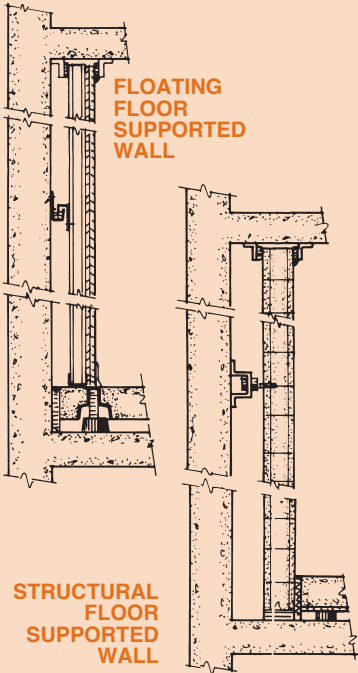

FLOATING FLOOR SUPPORTED WALL

STRUCTURAL FLOOR SUPPORTED WALL

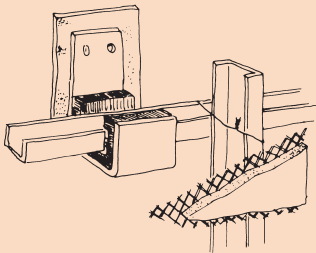

TYPICAL LIGHTWEIGHT WALL BRACE AND SUPPORT

Test Three BROADCASTING STUDIO

Frequency (Hz)	Transmission Loss (dB)
100	47
125	48
160	50
200	54
250	60
315	66
400	71
500	79
630	85
800	90
1000	95
1250	92
1600	92
FSTC	71
INR	+24

Cerami Field Test 2501, July 1, 1974

Walls are isolated to prevent flanking around floating floors or to improve the STC between adjacent spaces.

The word “flanking” is used to describe a vibration or noise path that goes around an isolated component. If a structure is built with continuous walls so that in cross section it is as an H and we introduce a floating floor, the STC of the system will probably remain at only 60 or 63 regardless of the floor’s rating. Sound energy vibrates the walls and this vibration continues in wave form to the lower spaces where the wall reintroduces the sound. This is flanking or bypassing the floating floor. The difference in results is shown in Test Two as opposed to Test One in the beginning of our discussion on page 3. The floor constructions were exactly the same. In Test One, however, the sound impinged directly on the walls and ceiling without the isolated barrier walls and ceiling used in Test Two.

To complete an envelope, secondary walls must be introduced with the same consideration given to mass and air gap as covered in the floor discussion. The problem is simpler, because the walls normally support only their own weight and they need not have the structural strength of the floor. Poured concrete or concrete block walls should approach the floor density. It is most important that block joints are properly filled with mortar and painting the walls so the construction is more nearly airtight helps.

The best approach is resting these walls on the perimeter of the floating floor so the floor isolation system serves the walls as well. If this is not possible, the second choice is supporting the isolated wall on the structural slab with continuous LDS pads, and providing a caulked fiberglass seal between the floating floor and the wall as described for the perimeter in the previous specifications.

If the wall is so high as to be unstable it must be protected against buckling or toppling by means of resilient sway braces anchored to the structural walls. Sway braces are mandatory for all independent walls resting on pads if they are not locked at the top. Braces are normally placed 4’ apart horizontally with the vertical spacing of rows dependent on the height and thickness of the wall. It is seldom that more than two rows of braces are required.

Occasionally we have used double acting springs for sway braces in conjunction with spring mounted floors. In most cases, however, our recommended design is the LDS Type DNSB as illustrated on page 20. When space is limited, the WIC clip is the logical alternate. (Page 20)

Yet another variation, Type WCL, consists of a channel shaped bracket that is lined with 5/16” LDS waffle pad and a 1/4” thick felt backing. With this arrangement the bracket is bolted to the structural wall so that horizontal steel furring can be laid in the isolated pocket as illustrated. (Page 20)

When we did our test work at Riverbank, we did not place lightweight fiberglass fill between the walls of our inner room and the walls of the laboratory. Concrete short circuited the air gap and we had to break it out. Therefore, under Construction Procedure you will find that we have said that “special care must be taken to completely butter all joints and concrete must not be allowed to drop behind the wall and short circuit the air gap”.

If you wish to be more cautious about concrete droppings, you can call for 1 1/2” or 2” thick three pound minimum density fiberglass to fill this vertical void. Call for the fiberglass in the materials portion of the specification and then in the construction procedure advise the contractor to cement the fiberglass to the structural wall in advance of the placing of the concrete blocks. Thus, the fiberglass will serve to prevent accidental short circuiting of the air gap. It is primarily a mechanical rather than an acoustical aid.

We must also be concerned with sound leakage over the top of the wall. If a wall is short and rigid and need not be locked at the top, the least expensive approach is the inclusion of a fiberglass pad over the last course of masonry with acoustical caulking on both sides of the pad. In most cases, it is easier to both lock the walls in place and seal them by the use of continuous angle brackets type AB-716 which are placed on both sides of the wall as illustrated on page 20.

If the walls are stable and it is possible to rest the floating ceiling on the floating walls to complete the box, there is no need for these top details.

When an isolated wall abuts the rigid structure, it is usual to place a fully caulked strip of fiberglass or 1/2” neoprene sponge at the end to prevent short circuiting. AB-716 angle braces can be used vertically as well for locking purposes or a caulked vertical section of channel iron lined with 1/2” neoprene sponge makes another neat joint as the wall fits between the flanges.

If some lesser STC values are satisfactory, it is not necessary to use masonry. Good results can be obtained with gypsum board walls or various of the prefabricated acoustical partitions as shown by Test Three of a small broadcasting studio using a 4” jack-up concrete floor, gypsum board walls on three sides and an isolated ceiling. You will note that rather than the 79 STC obtained with the 2” air gap in the Riverbank Test, this room came in at FSTC 71 with an INR of plus 24. These are excellent results and probably more than satisfactory for most situations. This less expensive construction should certainly be considered. The type WCL clip was used to resiliently support horizontal runners and we had included fiberglass behind the walls as always for lightweight construction.

Isolated walls are often used without floating floors to reduce sound transmission between adjacent spaces. Here the floor provides a possible flanking path, but if results in the STC 60 range are satisfactory this is certainly a valid technique. All of the wall specifications are meant to be used with or without the floor specifications as required.



ISOLATED WALLS RESTING ON FLOATING FLOOR specification

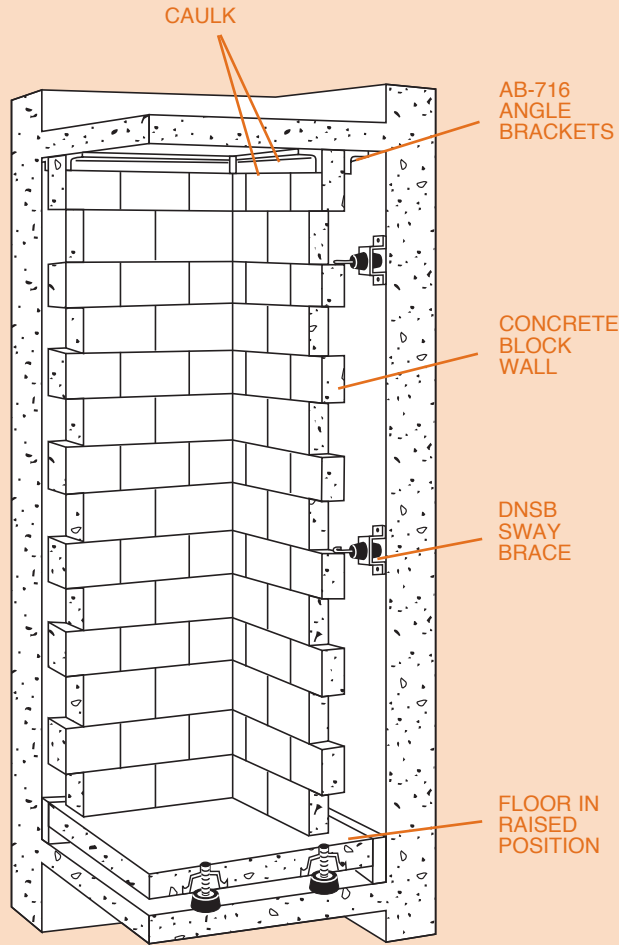

PRODUCT DETAILS

DNSB Sway Braces

Min Braced Weight to Establish 10Hz (lbs)	Max Assigned Wall Weight (lbs)	A (in)	B (in)	C (in)
50	250	2	3	33/4
400	1200	2 1/2	3	4 1/4

Wall must be supported at the base. Theoretical horizontal load is zero and assigned maximum weight is limited by possible development of buckling or overturning forces.

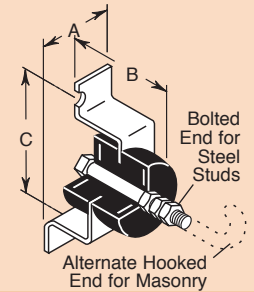

WIC Sway Braces

Min Braced Weight to Establish 15Hz (lbs)	Assigned Max Weight per Brace (lbs)	A (in)
50	250	1
100	500	2

Wall must be supported at the base. Theoretical horizontal load is zero and assigned maximum weight is limited by possible development of buckling or overturning forces.

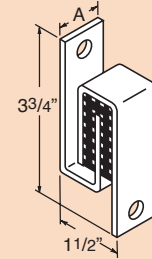

WCL Sway Braces

Min Braced Weight to Establish 15Hz (lbs)	Assigned Max Weight per Brace (lbs)
100	500

Wall must be supported at the base. Theoretical horizontal load is zero and assigned maximum weight is limited by possible development of buckling or overturning forces.

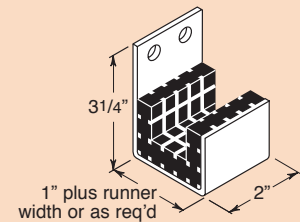

SWW Wall Isolators

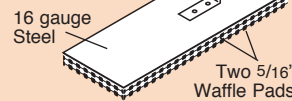

AB-716 Angle Brackets

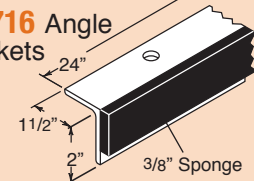

NOTE: The floating floor specifications already include provision for floating walls. The following independent specification is provided for additional clarity.

MASONRY WALL ISOLATION, WALLS RESTING ON FLOATING CONCRETE FLOOR

A. Scope

Isolate masonry walls shown on drawings from building structure by supporting them on the floating concrete floor. Brace them with resilient sway braces and anchor the top by means of resiliently lined angle iron guides.

B. Materials

1. Wall Sway Braces: Double acting LDS sway braces with a fail safe feature in three planes. Braces shall be furnished with a bracket for bolting to the structural wall and a hooked end for insertion in the masonry joint. Braces shall have a frequency not in excess of 10Hz based on the weight of the wall area per brace and a vertical stiffness not in excess of 50% of the horizontal.
2. Angle Brackets: 1 1/2"(40mm) x 2"(50mm) angle iron sections with provision for bolting to the structure and a minimum thickness of 3/8"(10mm) sponge cemented to the vertical leg.
3. Caulking Compound: Non-hardening, non-drying and non-bleeding.

C. Wall System Construction Procedure

1. If the drawings call for sway braces, raise the floating floor to operating position before attaching the first row of sway braces to the walls. If no sway braces are used, construct the walls before raising floor if walls do not cover isolator access.

2. Build concrete block wall on perimeter of floating floor leaving a 3 1/2"(90mm) gap between the building wall and the floating wall. (3 1/2"(90mm) may be reduced to 2"(50mm) if no sway braces are needed.)
3. Cement 2"(50mm) fiberglass to the structural wall. When buttering all joints, concrete should not be allowed to drop behind the wall and short circuit the air gap. The fiberglass will prevent accidental droppings.
4. Set sway braces as shown on drawings and anchor hooks in mortar joints.
5. Bolt one angle bracket to structural ceiling with sponge leg facing new wall.
6. Continue construction to ceiling leaving a minimum gap of 1/2"(12mm) on top with the floating floor elevated. Check to be certain gap is continuous.
7. Secure other angle to structural ceiling with sponge leg vertical and bearing on wall. Angles shall be continuous on both sides of wall.
8. Caulk all accessible joints.

D. Submittals

1. Load and deflection curves of all sway braces in both planes.
2. Detailed drawings of angle braces.

E. Manufacturer

1. Subject to compliance with the specifications, the following products are approved for use: Type DNSB Sway Braces, AB-716 Angle Brackets and CC-75 Caulking Compound all as manufactured by Mason Industries, Inc.



ISOLATED MASONRY WALLS ON STRUCTURAL FLOOR and GYPSUM BOARD WALL specifications

The method below is used when walls are extremely tall and heavy so that support on the floating floor becomes impractical. There are also installations where only adjacent space must be protected and no floating floor is required.

MASONRY WALL ISOLATION, WALLS RESTING ON ISOLATION PADS.

A. Scope

Isolate masonry walls shown on drawings from building structure by supporting them on two 5/8"(16mm) thick LDS isolation pads, bracing them with resilient sway braces and anchoring the top by means of resiliently lined angle iron guides.

B. Materials

1. Wall Isolation Pads: Two layers of 5/16"(8mm) thick LDS waffle pad molded to the following AASHTO Table 1 properties and cemented to a 16 gauge sheet metal form cut to the full width of the wall. Sections shall be furnished 6'(2m) long with corrugated steel anchors riveted or welded to the plates to facilitate anchoring of the walls. Waffle pad may be cut in lengthwise strips to reduce area and allow for the proper deflection. Dynamic frequency shall not exceed 14Hz.

Table 1. AASHTO BRIDGE BEARING SPECIFICATIONS FOR POLYISOPRENE

ORIGINAL PHYSICAL PROPERTIES			TESTED FOR AGING			COMPRESSION SET	LONG TERM CREEP
Tests: ASTM D-2240 & D-412			OVEN AGING(70hrs/158°F)	OZONE			
Duro-meter Shore A	Tensile Strength (min)	Elongat. at Break (min)	Hard-ness (max)	Tensile Strength (max)	Elongat. at Break (max)	ASTM D-1149 25 pphm in air by Vol. 20% Strain 100°F	
40±5	2000 psi	500%	+10%	-25%	-25%	No Cracks	5%(max)
50±5	2250 psi	450%	+10%	-25%	-25%	No Cracks	5%(max)
60±5	2250 psi	400%	+10%	-25%	-25%	No Cracks	5%(max)
70±5	2250 psi	300%	+10%	-25%	-25%	No Cracks	5%(max)

NOTE: 40 Durometer is not included in AASHTO Specifications. Numbers are Mason standard.

2. LDS Cement

3. Wall Sway Braces: Double acting LDS sway braces with a fail safe feature in three planes. Braces shall be furnished with a bracket for bolting to the structural wall and a hooked end for insertion in the masonry joint. Braces shall have a frequency not in excess of 10Hz based on the weight of the wall area per brace and a vertical stiffness not in excess of 50% of the horizontal.

4. Angle brackets: 1 1/2"(40mm) x 2"(50mm) angle iron sections with provision for bolting to the structure and a minimum thickness of 3/8"(10mm) sponge cemented to the vertical leg.

5. Caulking Compound: Non-hardening, non-drying and non-bleeding.

C. Wall System Construction Procedure

1. Strike lines on the floors and cement the 6'(2m) long wall supports in position with LDS cement.
2. Cement 2"(50mm) fiberglass to the structural wall.
3. Lay the first course of blocks being certain to bend up the corrugated anchors to embed them in the mortar joints.
4. Build up the concrete wall taking special care to completely butter all joints. Where sway braces are used, leave a 3 1/2"(90mm) gap between the acoustical wall and the building structure. Do not allow mortar to drop behind wall and short circuit the air gap. The 2"(50mm) fiberglass will help prevent short circuiting.
5. Set sway braces as shown on drawings and anchor hooks in mortar joints.
6. Bolt one angle bracket to structural ceiling with sponge leg facing new wall.
7. Continue construction to ceiling leaving a minimum gap of 1/2"(12mm) on top. Check to be certain gap is continuous.
8. Secure other angle to structural ceiling with sponge leg vertical and bearing on wall. Angle shall be continuous on both sides of wall.
9. Caulk all joints.

D. Submittals

1. Load and deflection curves of all sway braces in both planes. Load and deflection curves of wall isolation pads. Detail drawings of angle braces.

E. Manufacturer

1. Subject to compliance with the specifications, the following products are approved for use: Type SWW Wall Isolators, DNSB Sway Braces, AB-716 Angle Braces and CC-75 Caulking Compound. All as manufactured by Mason Industries, Inc.

NOTE TO ARCHITECT:

When you cannot leave a 3 1/2"(90mm) gap between the isolated wall and the basic structure, it is necessary to use a stiffer type of sway brace as the LDS materials must be made thinner. If there is an inch and a half gap, the item can be defined as a "Double acting LDS

sway brace consisting of two interlocking metal sections separated by 5/16"(8mm) thick LDS waffle pad with a horizontal frequency not exceeding 15Hz based on the total weight of the wall area per brace". Under materials and manufacturer they should be referred to as type WIC rather than DNSB.

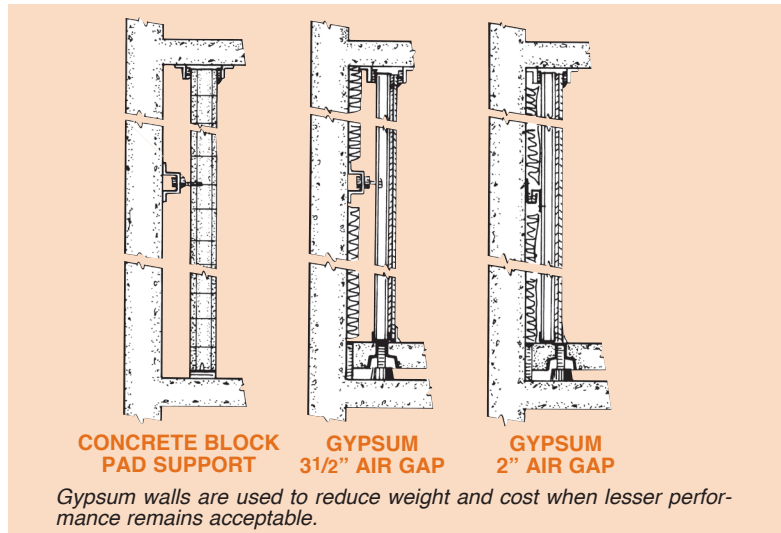

Gypsum walls are used to reduce weight and cost when lesser performance remains acceptable.

GYPSUM BOARD FLOATING WALLS RESTING ON FLOATING FLOORS

The following specification is meant as a general guide for the construction of gypsum board or similar sound barrier walls. There are so many variations in construction that our specifications can only be very broad and must be specifically tailored to each individual application.

A. Scope

1. Isolation of gypsum board walls from building structure by putting them on the floating concrete floor, bracing them with resilient sway braces and establishing a sound seal either at the structural or acoustical ceiling.

B. Isolation Materials

1. Wall Sway Braces: Double acting LDS sway braces with a fail safe feature in three planes. Sway braces shall be made with a bracket for bolting to the building structure and a projecting anchor bolt with adjusting nuts for plumbing the wall structure. Sway braces shall have a horizontal frequency not in excess of 10Hz based on the weight of the wall area per brace and a vertical stiffness not in excess of 50% of the horizontal.
2. Angle Brackets: 1 1/2"(40mm) x 2"(50mm) angle iron sections with provisions for bolting to the structure and a minimum thickness of 3/8"(10mm) sponge cemented to the vertical leg.
3. Caulking Compound: Non-hardening, non-drying and non-bleeding.
4. One and a half to three pound density fiberglass 2"(50mm) thick.

C. Wall System Construction Procedure

1. Raise the floating floor to operating position before constructing walls. Bolt the wall foot channel to the perimeter of the floating floor and set the vertical channels in position.
2. Bolt the sway braces to the structural wall as shown on the drawing and use the leveling nuts to plumb the channels and set them in their vertical position.
3. Attach 2"(50mm) fiberglass to building walls.
4. Add horizontal steel members in the normal manner and cover entirely with two layers of 3/4"(20mm) gypsum board staggering and overlapping all seams.
5. Where drawings indicate, gypsum board terminates at the structural ceiling, stop the gypsum board 1/2"(12mm) short of the ceiling and lock in place with the 1 1/2"(40mm) x 2"(50mm) isolation angles on either side with the sponge rubber facing the gypsum board.
6. Where the gypsum board forms a seal with the isolation ceiling, terminate the gypsum board as shown on the details without the angle iron braces.
7. Caulk all joints.

D. Submittals

1. Submittals shall include load and deflection curves of all sway braces.

E. Manufacturers

1. Subject to compliance with the specifications the following products are approved for use: Type DNSB Sway Braces as manufactured by Mason Industries, Inc.



ISOLATED SUSPENDED CEILINGS discussion

PRODUCT DETAILS

WHD LDS Hangers

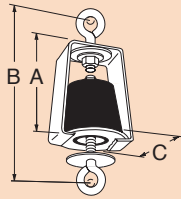

Load Range (lbs)	A (in)	B (in)	C (in)
Up to 125	23/4	41/8	2
Up to 650	41/2	7	41/4

W30 Spring Hangers

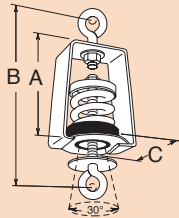

Load Range (lbs)	A (in)	B (in)	C (in)
12 to 95	41/2	71/4	23/4
138 to 336	43/8	73/8	4

W30N LDS & Spring Hangers

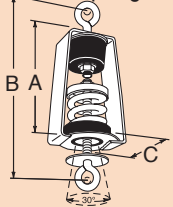

Load Range (lbs)	A (in)	B (in)	C (in)
12 to 95	51/2	10	31/2
138 to 336	81/4	11	43/4

Test FOUR TRANSMISSION LOSS TEST (KAL-714-9-69)

Frequency (Hz)	Lightweight Gypsum 3" Floor Only	3" Lightweight Gypsum Floor & Suspended 5/8" Ceiling
125	27	35
160	26	32
200	31	36
250	32	39
315	30	39
400	33	43
500	38	47
630	38	50
800	41	53
1000	43	57
1250	44	59
1600	45	64
2000	48	67
2500	51	69
3150	51	71
4000	54	76
STC	41	50

5/8" Gypsum board ceiling suspended 12" below 3" gypsum concrete floor and hung from W30N hangers.

There are two types of resiliently suspended ceilings.

The most common is a lightweight mechanical ceiling that contains the lighting fixtures, the outlets for the air conditioning system, etc. These lightweight ceilings consist of light steel framing drop-in absorptive tiles that are generally 24"x24" or 24"x36". The primary purpose is to absorb sound within the room and to lower the reverberation rate. Because the material is so light, there is virtually no reduction in transmitted noise either in or out of the room.

Acoustical barrier ceilings are entirely different. In years past they might have been plaster on wire lath, but modern construction is two layers of 5/8" gypsum board screwed together with staggered joints. Every effort is made to seal the perimeter as well as any penetrations. While these ceilings are still lightweight as compared to concrete floating floors, they do have sufficient mass to act as sound barriers and the fact that they are carefully caulked and sealed puts them in a totally different category than the mechanical ceilings described above.

Barrier ceilings are primarily used to reduce noise transmission from the floor above. In most cases an architect will choose either a floating floor in the equipment room or a barrier ceiling in the space below. However, the two methods are sometimes used in conjunction with one another.

In other applications the ceilings help contain noise. Thus, an equipment room may have a suspended ceiling to complete the isolated wall and floor design. This is a common procedure for adjacent music practice rooms, particularly when the double partition walls do not reach all the way to the structural ceiling.

Barrier ceilings are light as compared to floating concrete floors, so the effectiveness of the ceiling is far more dependent on the air gap than mass or rigidity. Since the air must allow for the inclusion of the hangers and support steel, a minimum air gap is about 12". Lightweight fiberglass bats are placed over the barrier ceiling to further improve the performance.

The building service ducts, electrical conduits, etc., pass beneath it and above a removable tile mechanical acoustical ceiling. The acoustical hangers are located in the supporting rods or wires common to both ceilings. When the barrier ceiling is penetrated by wires, rods or straps, these members must be isolated by means of resilient sleeves and they should be caulked as well.

While the double ceiling method is probably the most effective approach to the problem, vibration hangers are commonly used to support single ceiling systems as well. If the single ceiling is of the sound barrier type, the vibration isolator helps to prevent the passage of structural noise just as in the case of the double ceiling. Hangers used to support simple mechanical ceilings prevent rattling of the ceiling members.

A mounting that "looks into" or rests on a rigid structure has a simpler task than one working against something that is flimsy. In the case of floating floors, the LDS isolators or springs rest on the main structure, which is comparatively rigid. In the case of ceiling hangers, we often start with the noise and vibration at the concrete building structure and move down a rod or wire to the vibration control hanger and then on to the suspended ceiling. Under the best of circumstances, when this is a plastered ceiling, it is still a very flexible diaphragm without concentrated mass as compared to the concrete floor that a floor mounting rests on. Therefore, a hanger must be very carefully designed or it will not have the comparative flexibility to do the job.

Very little test work has been done to show the effectiveness of acoustical ceilings using isolation hangers. In 1969 we tested lightweight components. We started with a 3" gypsum concrete floor with an STC of 41 and suspended a single 5/8" gypsum board ceiling using W30N hangers with 1" static deflection. The air gap was 12". The STC went up to STC 50 for an improvement of nine as tabulated in Test Four. Most ceilings are made up of two layers of 5/8" gypsum board with lightweight fiberglass bats laid over the top. Therefore, it is safe to assume that the average barrier ceiling provides an improvement of STC 14.

We manufacture a very wide range of ceiling hangers in order to be competitive when other vendors are specified. In this bulletin, however, we are discussing only three major categories consisting of the WHD, W30 and W30N. Our suggestions are as follows:

Series WHD - Simple LDS vibration hangers are used in low budget applications or for those installations where it has been clearly established that there is little or no structural vibration. The hangers serve as noise breaks only, as static deflection is limited.

Series W30 - Steel coil spring vibration hangers are far superior to the LDS designs because the higher deflection spring element will serve to isolate building vibration. The design includes a LDS cup in series with the spring that acts as a partial high frequency noise barrier.

Series W30N - Combination hangers make use of the WHD LDS element in series with the W30 spring. Thus the design combines the best features of the all LDS and the spring hangers and we recommend them for all critical applications.

15° Misalignment Tolerance - Both our spring and combination spring and LDS hangers are designed so that the hanger rod or wire can be off vertical by as much as 15° without rubbing on the steel hanger box and transmitting noise. We continue to manufacture lower priced competitive hangers that do not have this angular tolerance, but we invented the 30° sweep design, because most field problems stem from a contractor's difficulty in lining up what may be hundreds of hangers perfectly. If they do not, the wires and rods rub.

Precompression - We strongly recommend that all spring hanger installations have the spring elements partially precompressed at the factory before they are installed. If the springs are not precompressed, the ceiling will descend as much as an 1" when the spring deflects as weight is added. The contractor will have great difficulty in preventing cracks in plaster ceilings or finishing with a flat ceiling at the proper elevation. When the spring hangers are precompressed 70% of the total travel, the ceiling will not descend at all until the installation is about completed and the travel will only be 0.30" to completion.

The architectural drawings should show the construction of the isolated ceilings and the spacing of the ceiling hangers. They are usually on 48" centers in both directions. The hanger most commonly used on our jobs and our standard recommendation is the Type W30N. Under Materials and Manufacturer, however, we have repeated the specification for each type so you can select your preference. Since the construction procedure is the same in all cases, it was pointless to keep rewriting the same specification over again. By the same token, the specification can be changed slightly to cover any type of construction such as a sand plaster ceiling or a simple acoustical tile ceiling by substituting your materials where we call for two layers of 5/8" Gypsum Board.



ISOLATED SUSPENDED CEILINGS specification

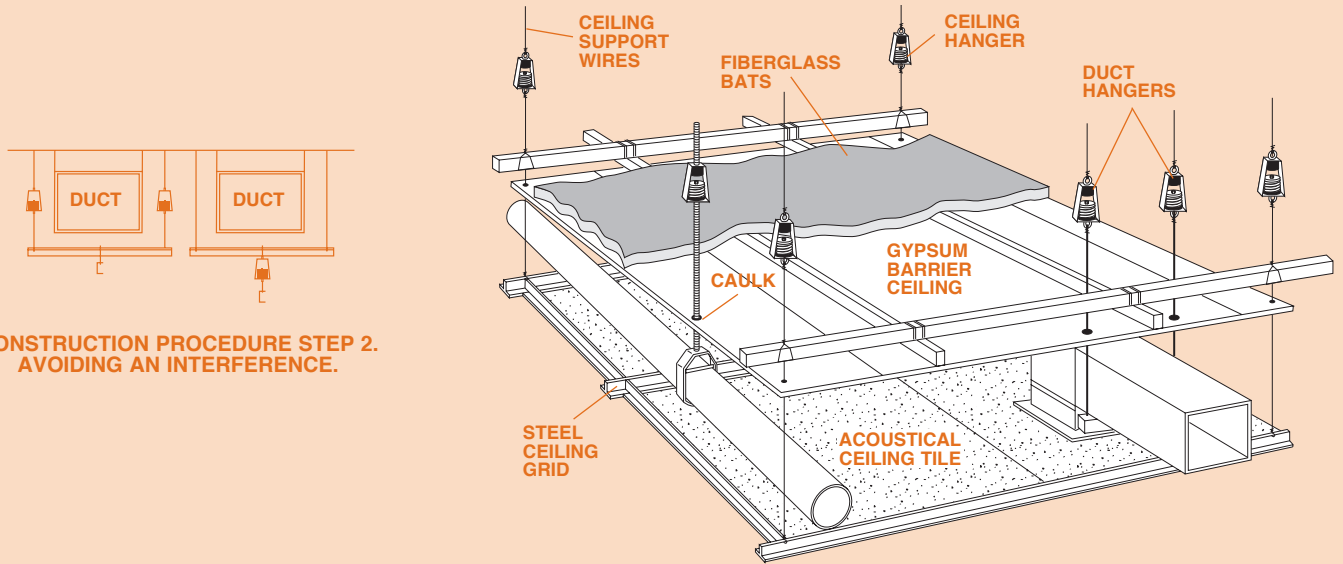

ISOLATED CEILINGS SUSPENDED BY RESILIENT HANGERS

A. Scope

To prevent the transmission of noise and vibration through the ceiling hangers and the suspended ceiling.

B. Materials

(Select one of the following as 1)

1. Combination LDS Element and Spring Hangers: Hangers shall consist of a steel frame containing an LDS isolation element at the top and a coil steel spring seated in an LDS cup on the bottom. Both the element and the cup shall be molded with an LDS bushing that passes through the steel frame. The LDS element shall be capable of a minimum deflection of 0.23"(6mm) and the steel springs selected from a 1"(25mm) static deflection series with a minimum additional travel to solid of 1/2"(12mm). Spring diameters and hanger box lower hole size shall be large enough to permit the hanger rod to swing through a 30° arc before contacting the box and short circuiting the spring. Hangers shall be selected for a minimum of 0.75"(20mm) spring deflection and factory precompressed 70% of the total deflection determined by the assigned load per hanger. Hangers shall be manufactured with provision for bolting or attaching to the ceiling flat iron straps, wire, rods or steel runners. Hangers shall be fail safe.
1. Spring Hangers: Hangers shall consist of a steel frame containing a coil spring seated in an LDS cup. The cup is molded with a rod isolation bushing that passes through the hanger frame. Hangers shall be selected from a 1"(25mm) static deflection series with a minimum additional travel to solid of 1/2"(12mm). Spring diameters and hanger box lower hole size shall be large enough to permit the hanger rod to swing through a 30° arc before contacting the box and short circuiting the spring. Hangers shall be selected for a minimum 0.75"(20mm) spring deflection and factory precompressed 70% of the total deflection determined by the assigned load per hanger. Hangers shall be manufactured with provision for bolting or attaching to the ceiling flat iron straps, wires, rods or steel runners. Hangers shall be fail safe.
1. LDS Hangers: Hangers shall consist of a steel frame containing an LDS isolation element molded with a rod isolation bushing that passes through the hanger frame. Deflections shall be a minimum of 0.23"(6mm) and a maximum of 15% of the elements height. The dynamic frequency shall not exceed 10Hz. The isolation elements shall be molded to the following AASHTO Table 1 bridge bearing properties. Hangers shall be manufactured with provision for bolting or attaching to the ceiling flat iron straps, wires, rods or steel runners. Hangers shall be fail safe.

2. Closed cell neoprene sponge 1/4"(6mm) thick.
3. One and a half to three pound density 2"(50mm) thick fiberglass.

C. Isolated Ceiling Construction Procedure.

1. Lay out ceiling support wires on 48"(1220mm) centers in both directions.
2. Where ducts or other mechanical interferences occur, a rigid steel trapeze can be run under the interference and a ceiling hanger hung from the trapeze to maintain the 48"(1220mm) centers. Where head room does not allow for this, the steel trapeze can be installed with an isolation hanger on each end and a ceiling wire hung from the trapeze to the floating ceiling.
3. Install isolation hangers making certain that hangers are vertical and that they do not rub against pipe, duct, ceiling beams or other interferences.
4. Connect wires to lower end of hangers and proceed with steel ceiling grid construction in the normal manner. Attach the first layer of 5/8"(16mm) gypsum board to the ceiling steel covering the upper surface of the gypsum board with 2"(50mm) fiberglass bats as completely as possible.
5. Attach the second layer of 5/8"(16mm) gypsum board being certain to stagger the joints in all cases.
6. Install lightweight angles around the perimeter of the ceiling by bolting one leg to the wall and resting the 1/4"(6mm) neoprene sponge on top of the horizontal leg so as to provide a support for the perimeter.
7. Caulk the perimeter.
8. When an acoustical tile ceiling is to be used below the sound barrier ceiling, continue the hanger wires to the acoustical ceiling and caulk all hanger wire penetrations where they pass through the gypsum ceiling.
9. Where mechanical equipment, pipes or ducts fall below the barrier ceiling, provide additional hangers that are not connected to the barrier ceiling for this equipment and sponge sleeves where these rods pass through the barrier ceiling. Caulk the perimeter of all sleeves.
10. Continue with the construction of the acoustical tile ceiling in the normal manner.

D. Submittals

1. Load/deflection curves of all hangers. Certification of the LDS compound to the AASHTO specifications as well as the Dynamic Frequency.
(Use 2 for W30N or W30 only)
2. A full scale drawing of the hangers showing the minimum 30° contact arc in all planes. Submittals shall include compressed spring height and spring rates.

E. Manufacturer

Subject to compliance with the specifications, the following products are approved for use: (Select One) (Type W30N Combination Spring and LDS Hangers.) (Type W30 Spring Hangers.) (Type WHD Double Deflection LDS Hangers) as manufactured by Mason Industries, Inc.

Table 1. AASHTO BRIDGE BEARING SPECIFICATIONS FOR POLYISOPRENE

ORIGINAL PHYSICAL PROPERTIES	TESTED FOR AGING			COMPRES- SION SET	LONG TERM CREEP	
	OVEN AGING(70hrs/158°F)		OZONE			
Tests: ASTM D-2240 & D-412	ASTM D-573		ASTM D-1149	ASTM D-395	ISO8013	
Duro- meter Tensile Strength at Break Elongat. (min)	Hard- ness (max)	Tensile Strength at Break (max)	Elongat. (max)	25 pphm in air by Vol. 20% Strain 100°F	22hrs/158°F Method B	168 hrs
40±5	2000 psi	500%	+10% -25% -25%	No Cracks	25%(max)	5%(max)
50±5	2250 psi	450%	+10% -25% -25%	No Cracks	25%(max)	5%(max)
60±5	2250 psi	400%	+10% -25% -25%	No Cracks	25%(max)	5%(max)
70±5	2250 psi	300%	+10% -25% -25%	No Cracks	25%(max)	5%(max)

NOTE: 40 Durometer is not included in AASHTO Specifications. Numbers are Mason standard.



WOODEN FLOATING FLOORS discussion & specification

It is often necessary to provide a wooden floating floor rather than the heavier concrete construction with wood topping. Cost or weight restrictions may be the factor. In older buildings it is often necessary to improve on existing floors with a lightweight impact noise resistant construction. A resiliently supported wooden floor will reduce the rumbling noise of a bowling ball, the click, click of a woman's heels and that portion of a typical noise generated by a piano that travels down the piano legs and into the structure. It will offer only minor reduction of airborne sound, as there is insufficient mass in the surface. In some applications on stages or in rehearsal rooms the primary purpose is relief and comfort for the dancers. Landing on concrete or hard mounted wood surfaces is very damaging to a dancer's feet and legs.

We have run some tests on INR and IIC as noted below, and hope to run other tests on STC, but have not done so at this writing. We have seen meaningful results, however, using this construction under judo rings, rehearsal dance floors, bowling alleys, gymnasium floors and high school machine shops.

In most cases, we have used our type ND mountings, and occasionally our type MFS spring designs. We have included a typical specification using the ND mountings and prefer not to write a general specification for springs, as spring selections are very construction dependent. Please let us help you specifically on direct mounted spring applications.

Our wooden floor specifications can be modified depending on your specific construction and finish. For example, rather than plywood you might be using heavy tongue and groove sub-flooring across the sleepers and a hardwood finish.

PRODUCT DETAILS

ND Double Deflection LDS Mounts

Height Saving ND Mounting Position

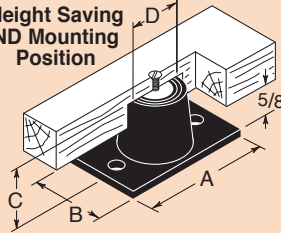

Simpler ND Mounting Position



Load Range (lbs)	Max Defl. (in)	Lowest Dynamic Freq. (60 Duro)	A (in)	B (in)	C (in)	D (in)
15 to 150	0.23	9 Hz	33/16	15/8	11/2	11/4
50 to 300	0.28	8 Hz	37/8	25/16	11/2	13/4
140 to 600	0.40	6.5 Hz	51/2	35/16	23/4	25/8

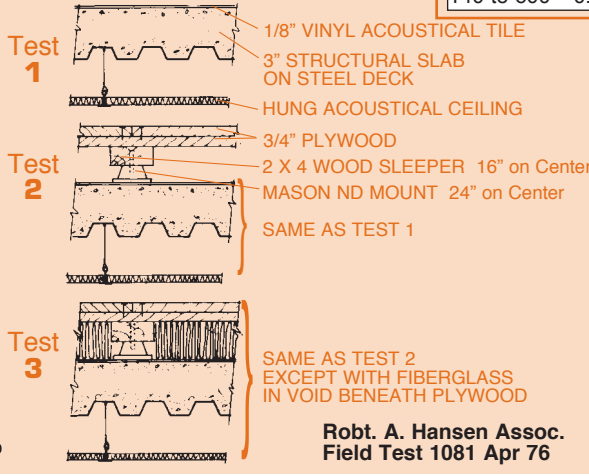
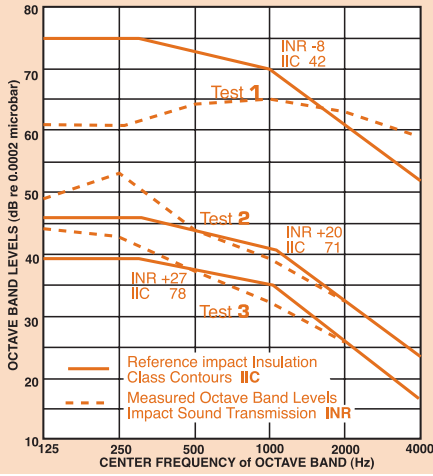

MFS Spring Floor Mounts

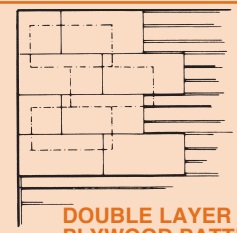
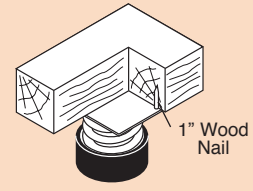

Robt. A. Hansen Assoc. Field Test 1081 Apr 76

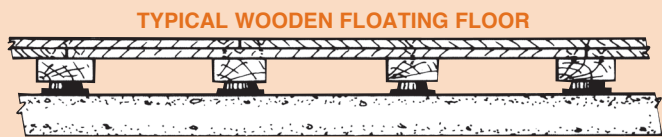

WOODEN FLOATING FLOORS FOR DANCE FLOORS, STAGE FLOORS, BOWLING ALLEYS, GYMNASIUMS, LIGHT DUTY MACHINE SHOPS, ETC.

- A. Scope**
Isolate the wooden floating floor from the building structure by means of double deflection LDS isolators and perimeter isolation.
- B. Materials**
- Sleepers: Kiln dried 2x4's minimum 12'(3.6m) long.
 - Flooring: 2 layers 3/4"(20mm) AC plywood.
 - LDS Isolators: Minimum of 1 1/2"(40mm) high with an extended LDS covered base plate and a tapped steel insert on top. Isolators shall be selected for a maximum of 0.23" deflection and shall be molded to the following AASHTO Table 1 Bridge bearing properties.

Table 1. AASHTO BRIDGE BEARING SPECIFICATIONS FOR POLYISOPRENE

ORIGINAL PHYSICAL PROPERTIES	TESTED FOR AGING			COMPRESSION SET	LONG TERM CREEP
	OVEN AGING (70hrs/158°F)	OZONE			
Tests: ASTM D-2240 & D-412	ASTM D-573	ASTM D-1149		ASTM D-395	ISO8013
Duro-meter Tensile Elongat. Strength at Break Shore A (min) (min)	Hard-ness Strength at Break (max)	Tensile Elongat. Strength at Break (max) (max)	25 pphm in air by Vol. 20% Strain 100°F	22hrs/158°F Method B	168 hrs
40±5 2000 psi 500%	+10%	-25%	-25%	No Cracks	25%(max) 5%(max)
50±5 2250 psi 450%	+10%	-25%	-25%	No Cracks	25%(max) 5%(max)
60±5 2250 psi 400%	+10%	-25%	-25%	No Cracks	25%(max) 5%(max)
70±5 2250 psi 300%	+10%	-25%	-25%	No Cracks	25%(max) 5%(max)

NOTE: 40 Durometer is not included in AASHTO Specifications. Numbers are Mason standard.

- Perimeter Isolation Sponge: Neoprene sponge 1/2"(12mm) thick.
- Fiberglass Insulation: Unfaced lightweight 1 1/2"(40mm) - 3# Density Fiber-glass Insulation Batts

- C. Floor System Construction Procedure**
- Cement 1/2"(12mm) thick neoprene sponge to walls around entire floor area. Neoprene strip should be full height of overall construction.
 - Counter bore holes on 24"(600mm) centers in underside of 2x4 sleepers so that the depth allows for an unloaded clearance of 5/8"(16mm) between the underside of the sleeper and the top of the isolator base plate. Holes shall be large enough to provide a minimum clearance of 1/4"(6mm) all around the diameter of the isolators. Bolt the isolators to the 2x4 with flat head machine screws in countersunk holes.
 - 2a. When height is not critical, use the following alternate. Invert the LDS isolator and nail securely to the underside of the 2x4 sleeper on the center line.
 - Place the sleepers all around the perimeter of the room up against the neoprene sponge perimeter isolation.
 - Place the balance of the sleepers in parallel rows on 16"(405mm) centers across the room as shown on the drawings.
 - Lay 1 1/2"(40mm) - 3# Density Fiberglass Insulation between rows of sleepers.
 - Attach the first 3/4"(20mm) layer of plywood to the sleepers with 2" (50mm) flat head screws on 16"(405mm) centers. Lay the rows of plywood down so the joints are staggered by 48"(1220mm) and the plywood is snug against the perimeter neoprene sponge.
 - Lay the second layer of 3/4"(20mm) plywood down with the joints offset 16"(405mm) in both directions in relation to the first layer. Attach the second layer of plywood to the first by means of 1 1/2"(40mm) long flat head wood screws on 16"(405mm) centers in both directions. Use wood glue between layers.
 - Apply floor finish as shown on the drawings.
- D. Submittals**
- Load and deflection curves of all isolators.
 - Certification of the elastomeric compound to the listed AASHTO specifications.
- E. Manufacturer**

The following products are approved for use: Double Deflection LDS Mountings manufactured to AASHTO specifications. Mountings shall be Mason Industries, Inc. Type ND-BBP.

We are represented throughout the United States and Canada as well as many other parts of the world. Please call New York or Los Angeles with your application problems. We are here to help you in every way possible.

SEND FOR OUR COMPLETE CATALOG



MASON INDUSTRIES, INC.

350 Rabro Drive, Hauppauge, NY 11788 • 631/348-0282 • FAX 631/348-0279
 2101 W. Crescent Ave., Suite D • Anaheim, CA 92801 • 714/535-2727 • FAX 714/535-5738
 Email info@Mason-Ind.com • Website www.Mason-Ind.com